

C.3 RCP Billing System Workflow

v4.4

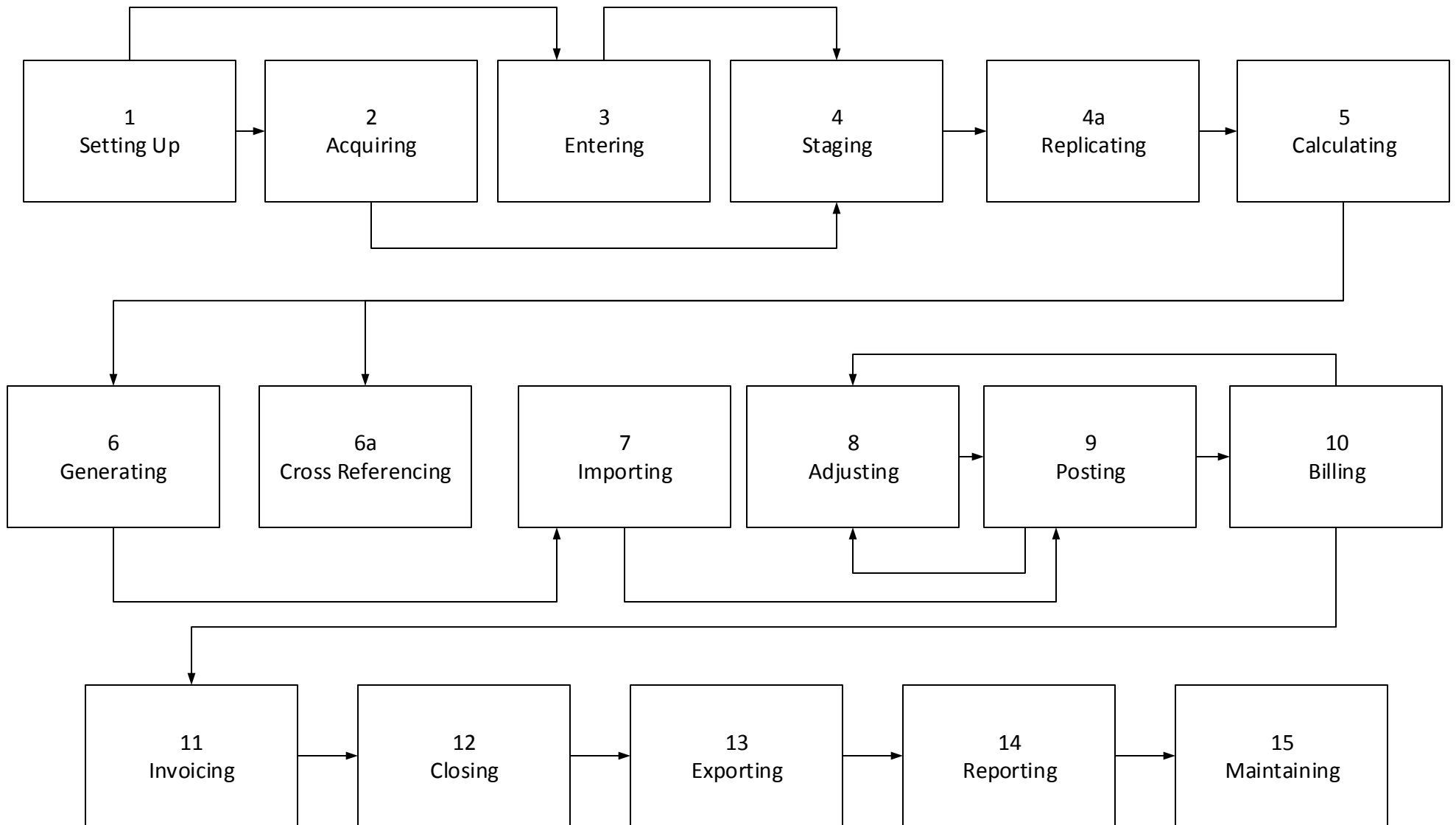

0.2 Web Server Architecture

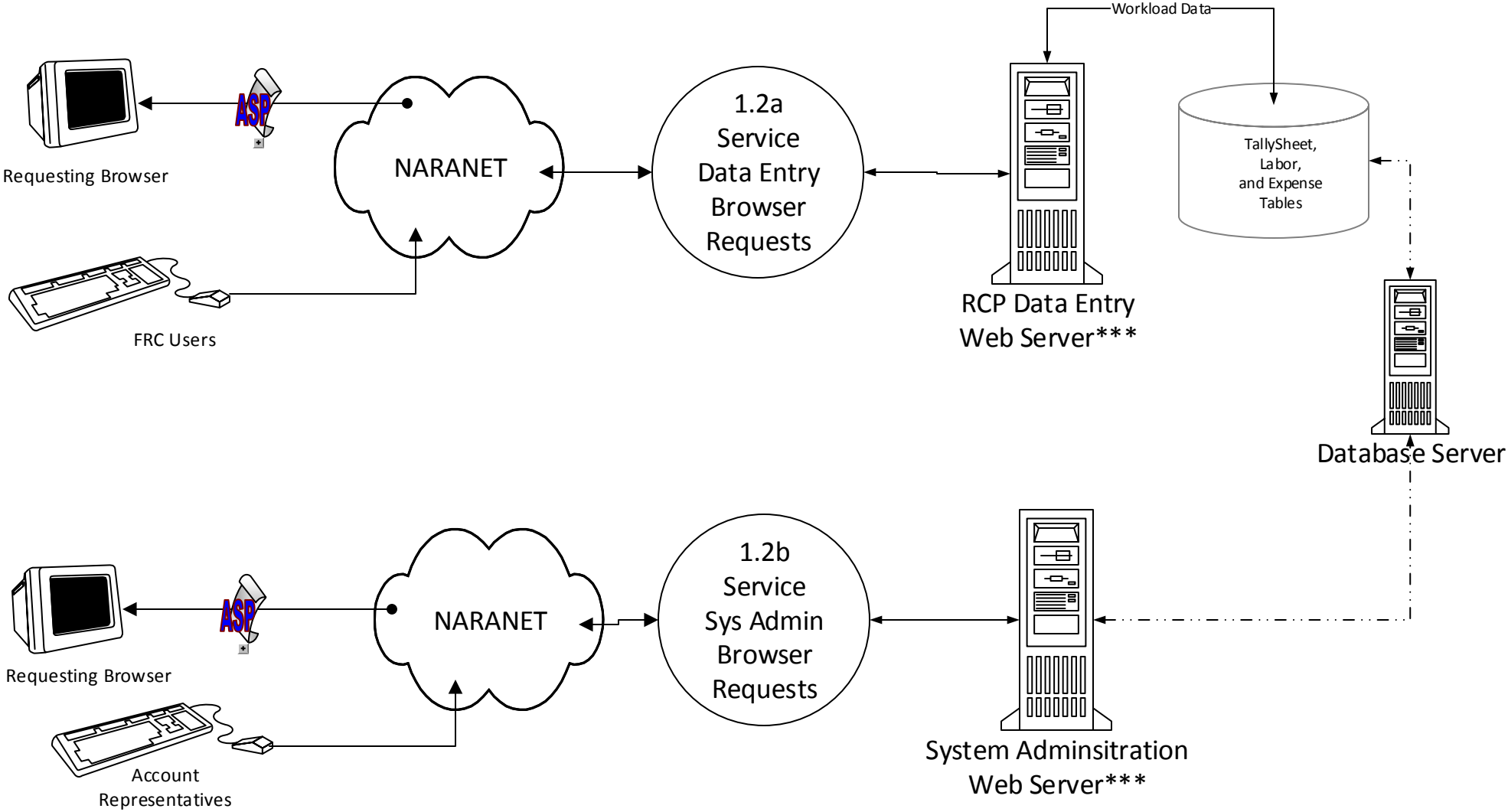

***Note: The 2 web sites (Data Entry and Sys Admin) are on the same physical servers

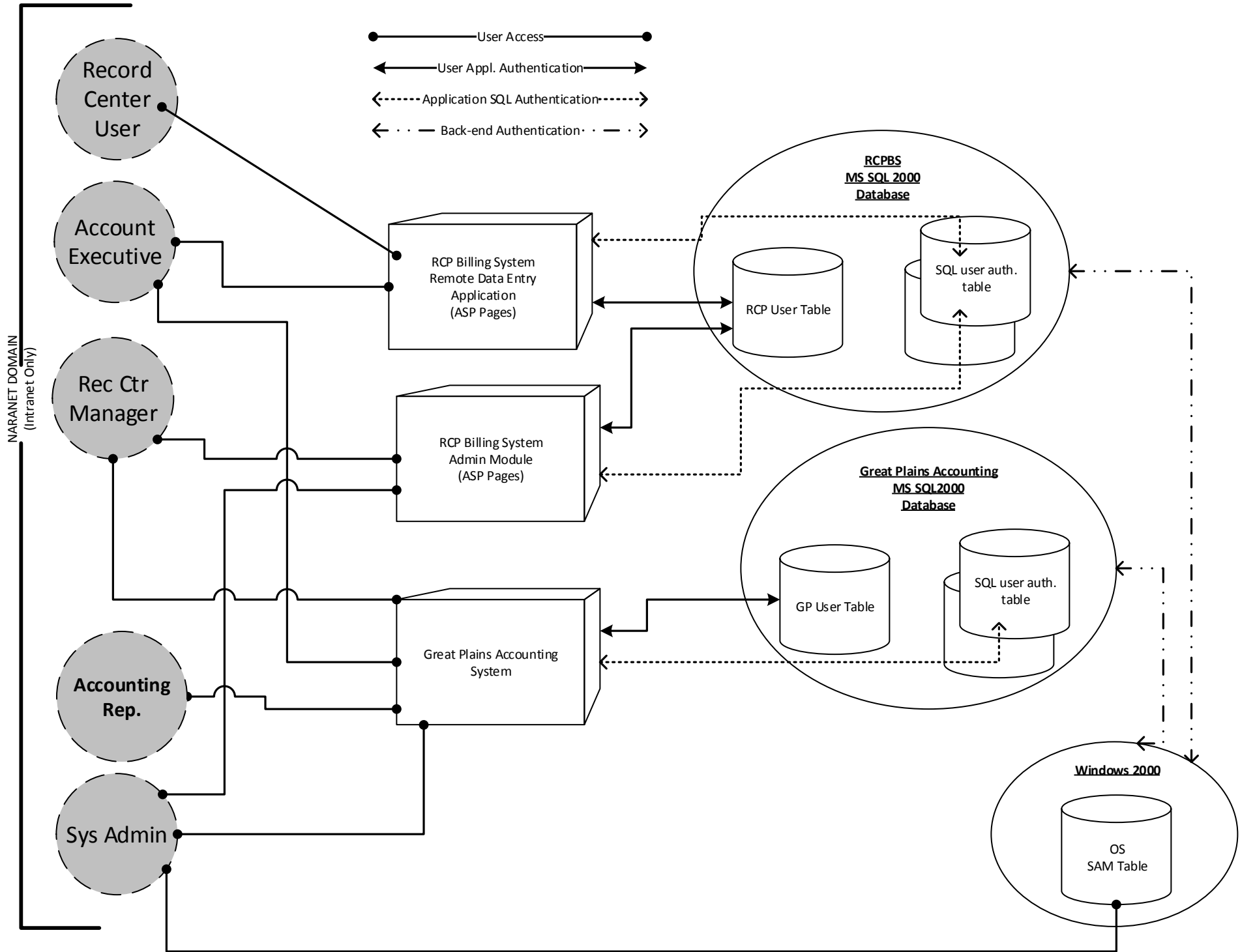

D.2 System Architecture Diagram - v4.5

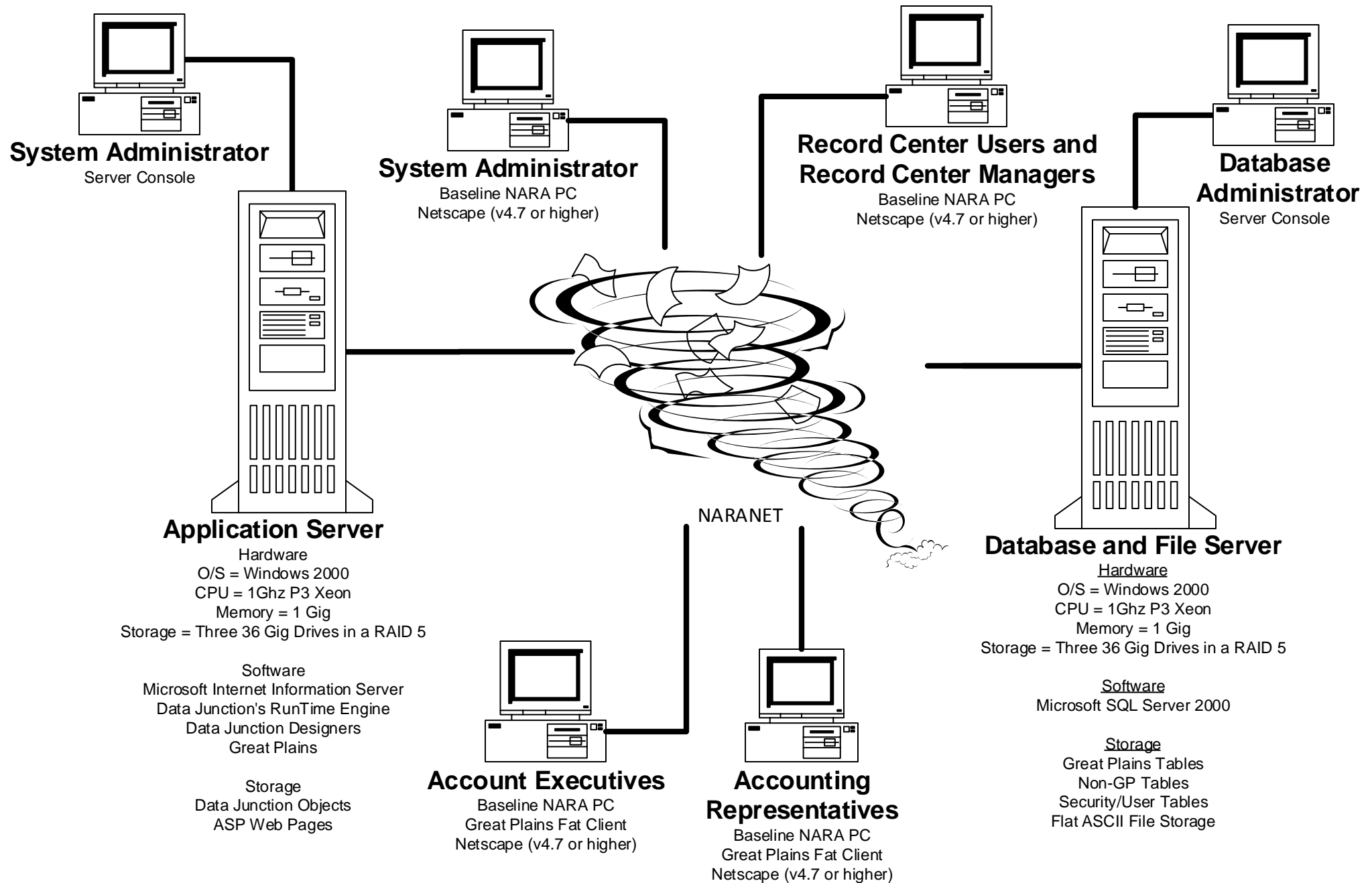

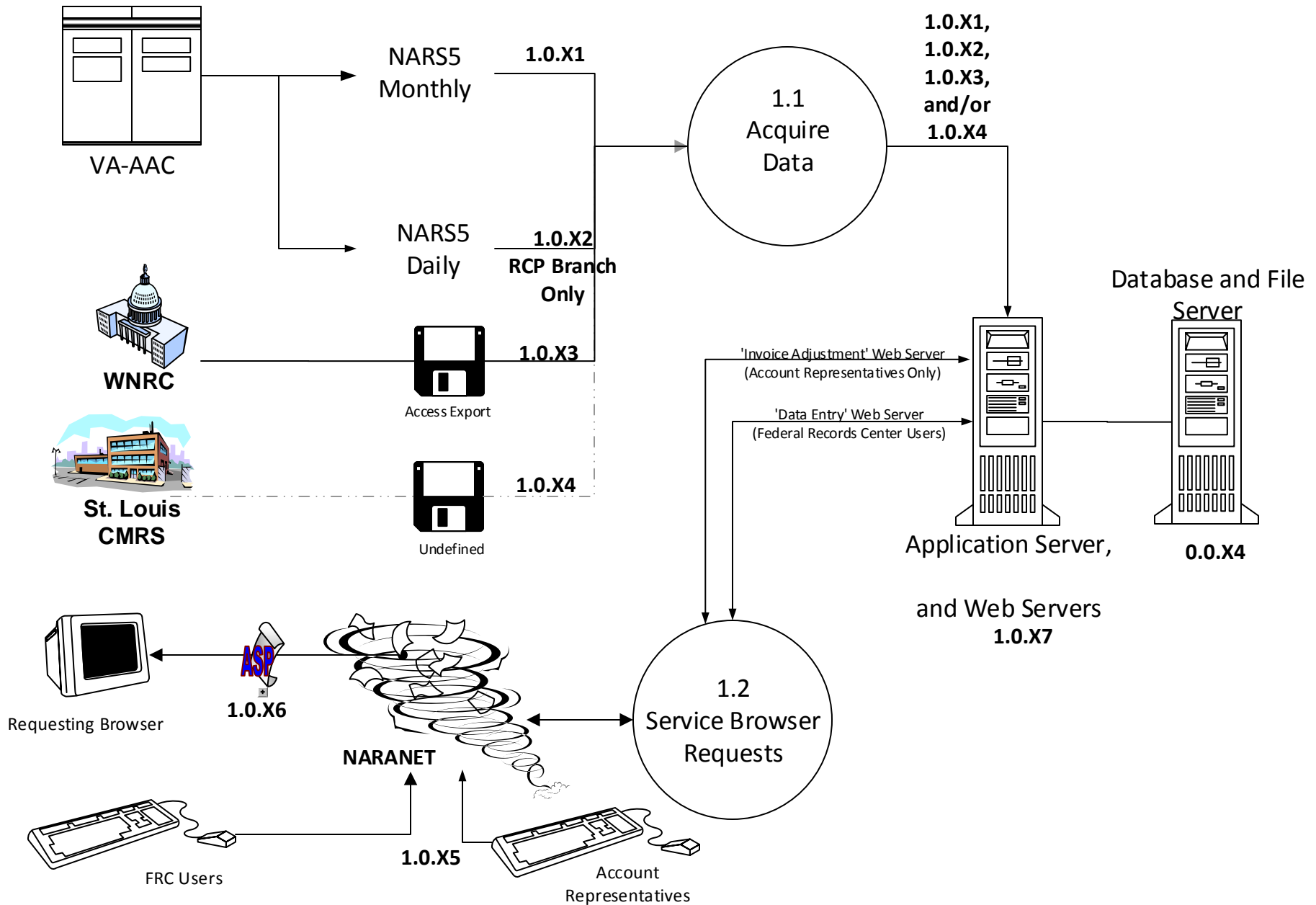

1.1 Acquire Data

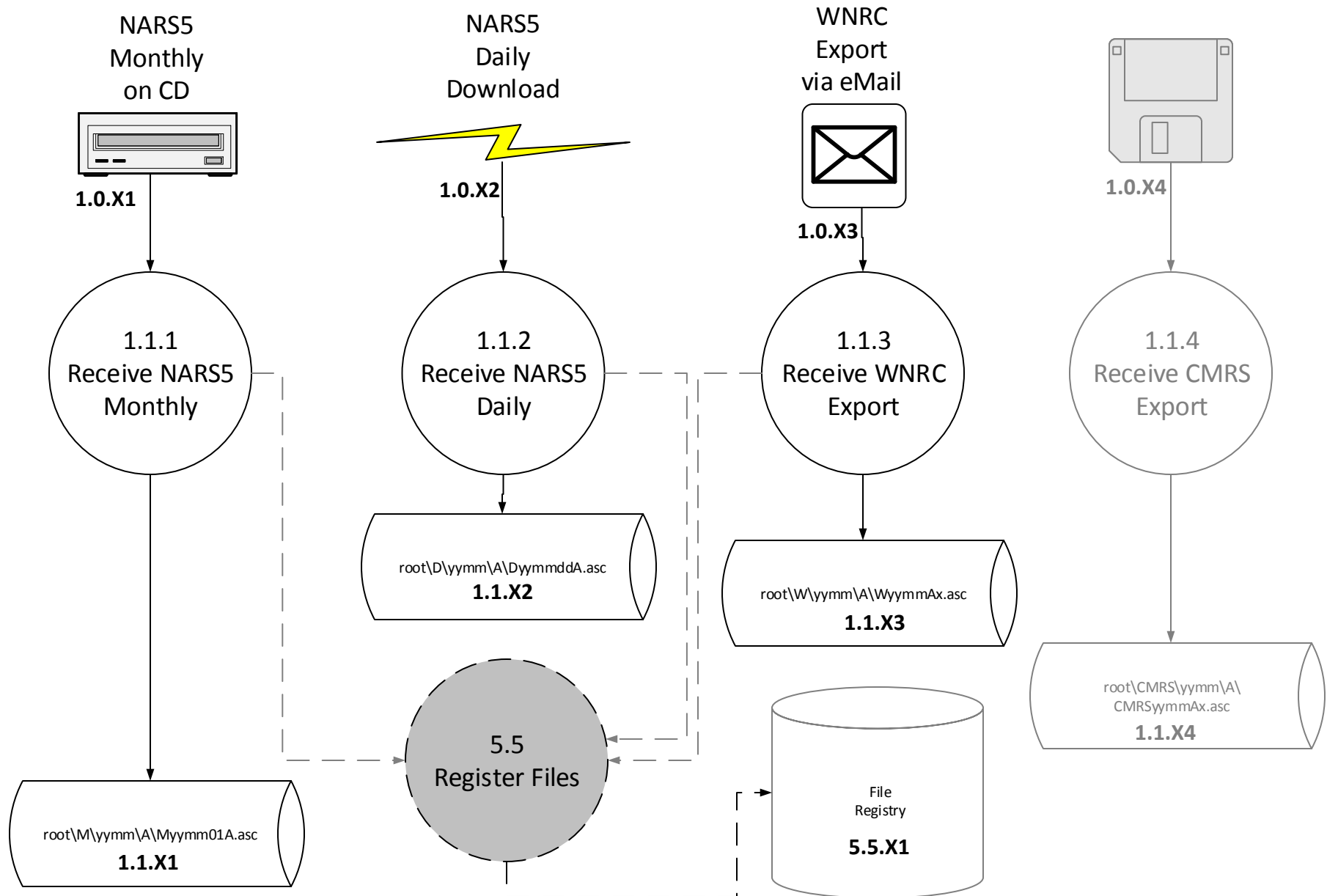

1.2 Service Browser Requests (page1)

v4.3



Up

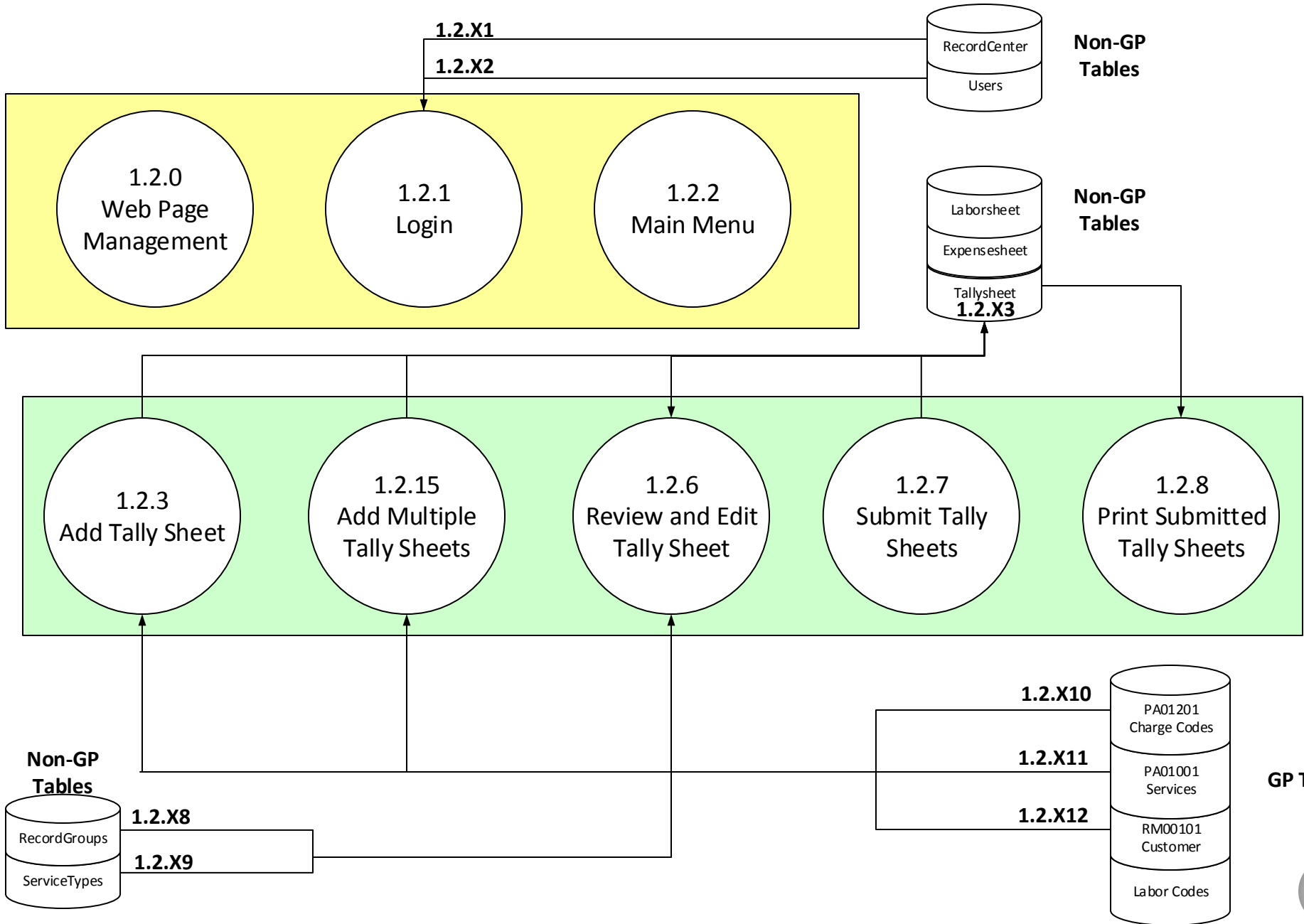

Next Page

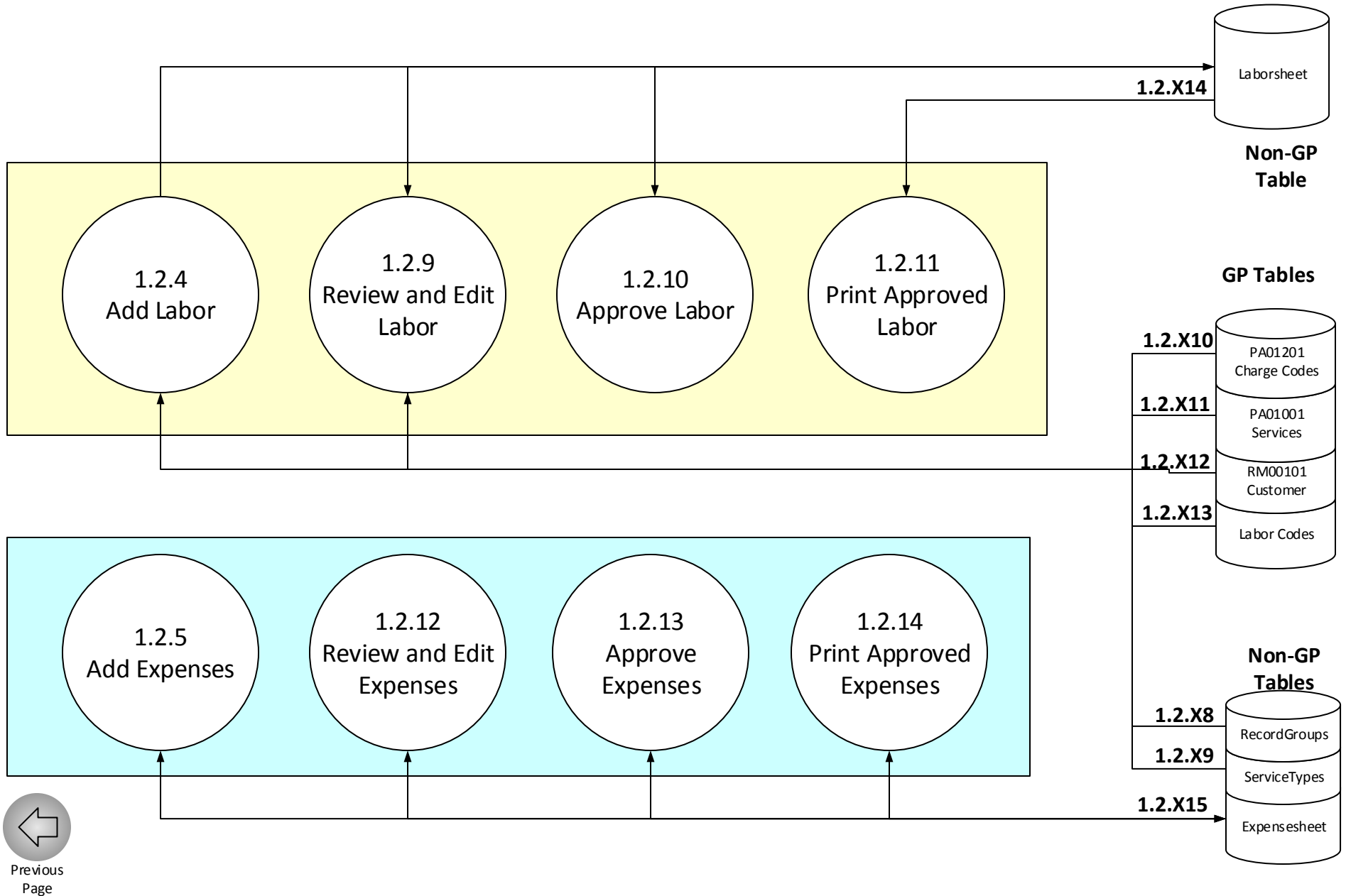



There are two development branches for the Transaction Generator.

One to generate billings based on the IBS algorithms(2.0a)

and

One to generate billings based on RCP Transactions (2.0b)

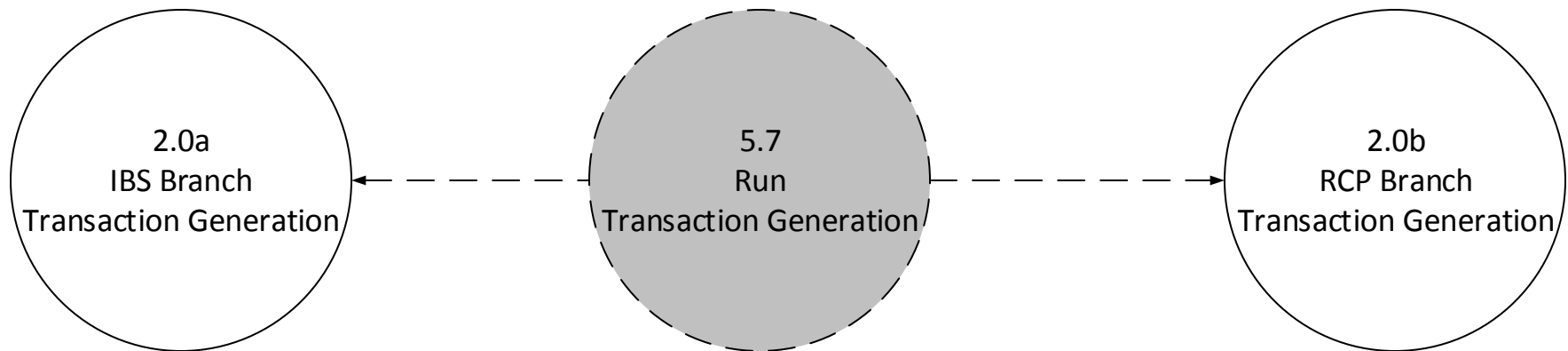

2.0a The IBS Branch does not process Daily Transaction files and uses the Monthly source file to generate both Storage and Service transactions. In addition, the Tally sheet table is populated using codes from the IBS Data Entry Web Site which uses different service codes than the RCP Billing System Data Entry web site.

2.0b The RCP Branch uses the Monthly source file to generate Storage transactions only. Service Transactions are not generated from holdings but from the the Tally sheet table which is populated by the RCP Billing System Data Entry web site. In addition the RCP branch has algorithms to process the Daily Transaction files.

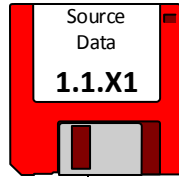

Tally Sheet Module

The IBS Branch does not process Tally Sheets from the FRCs

Accession and Disposal Module

The IBS Branch does not process NARS5 Daily source files

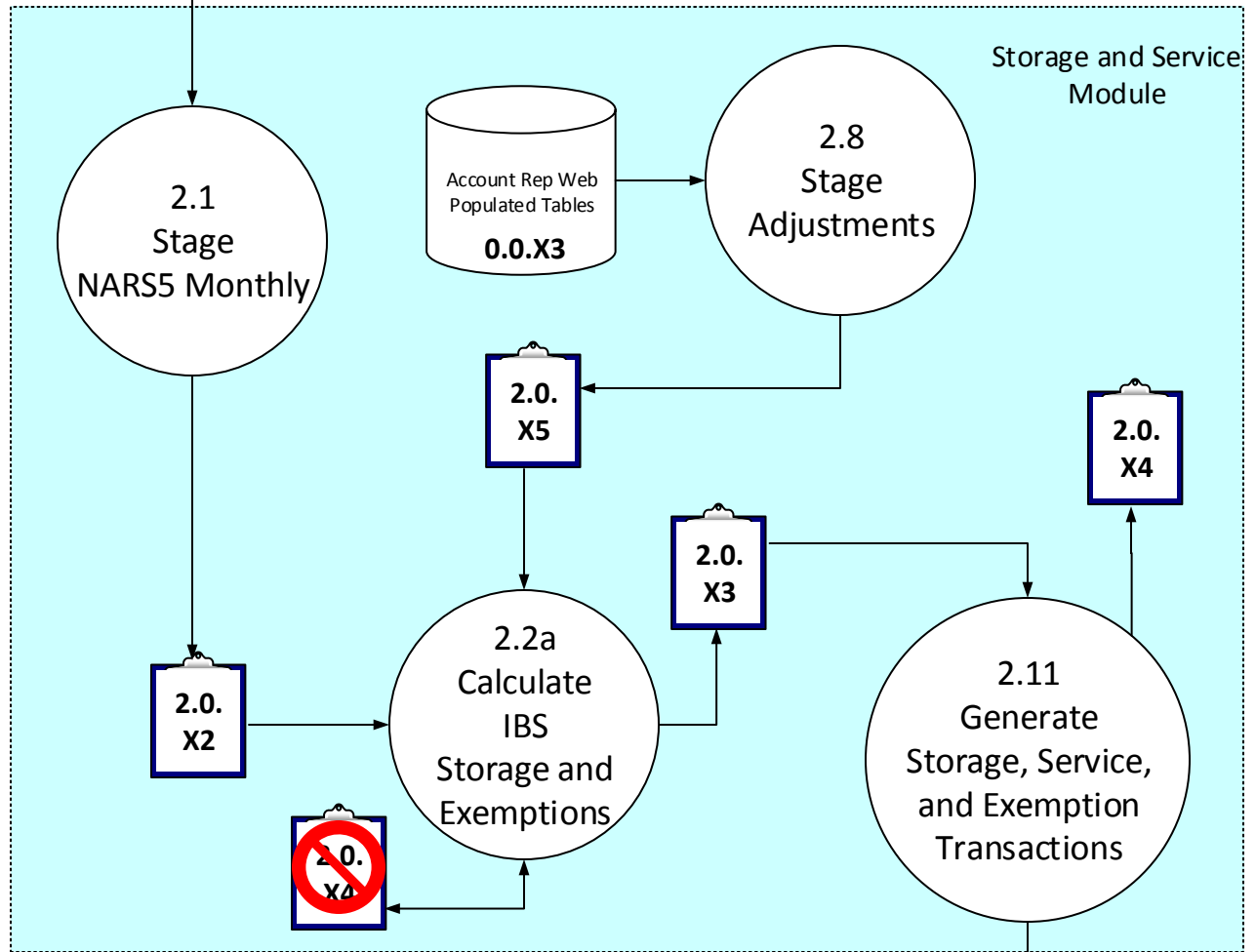

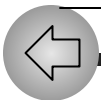
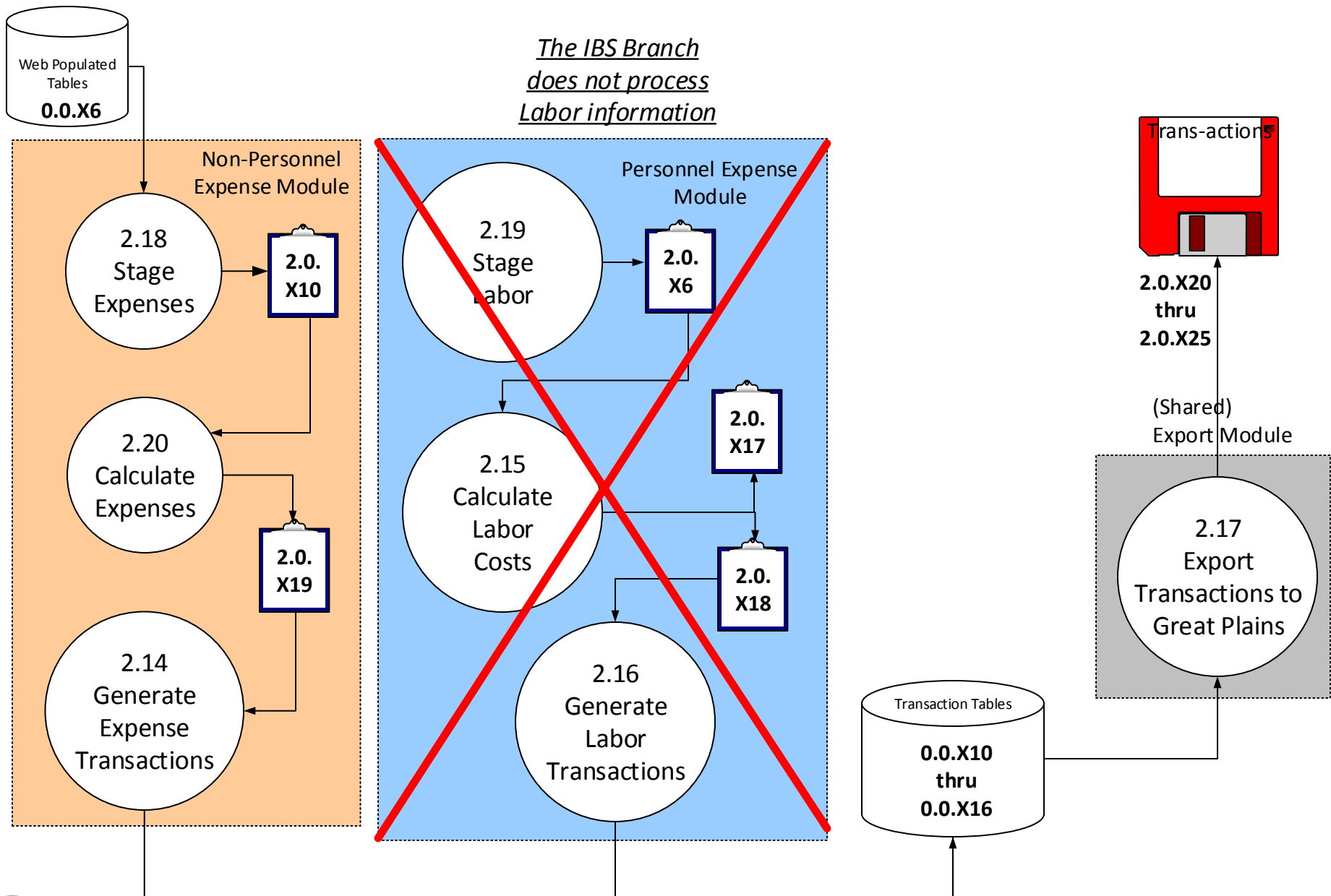

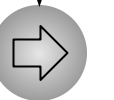
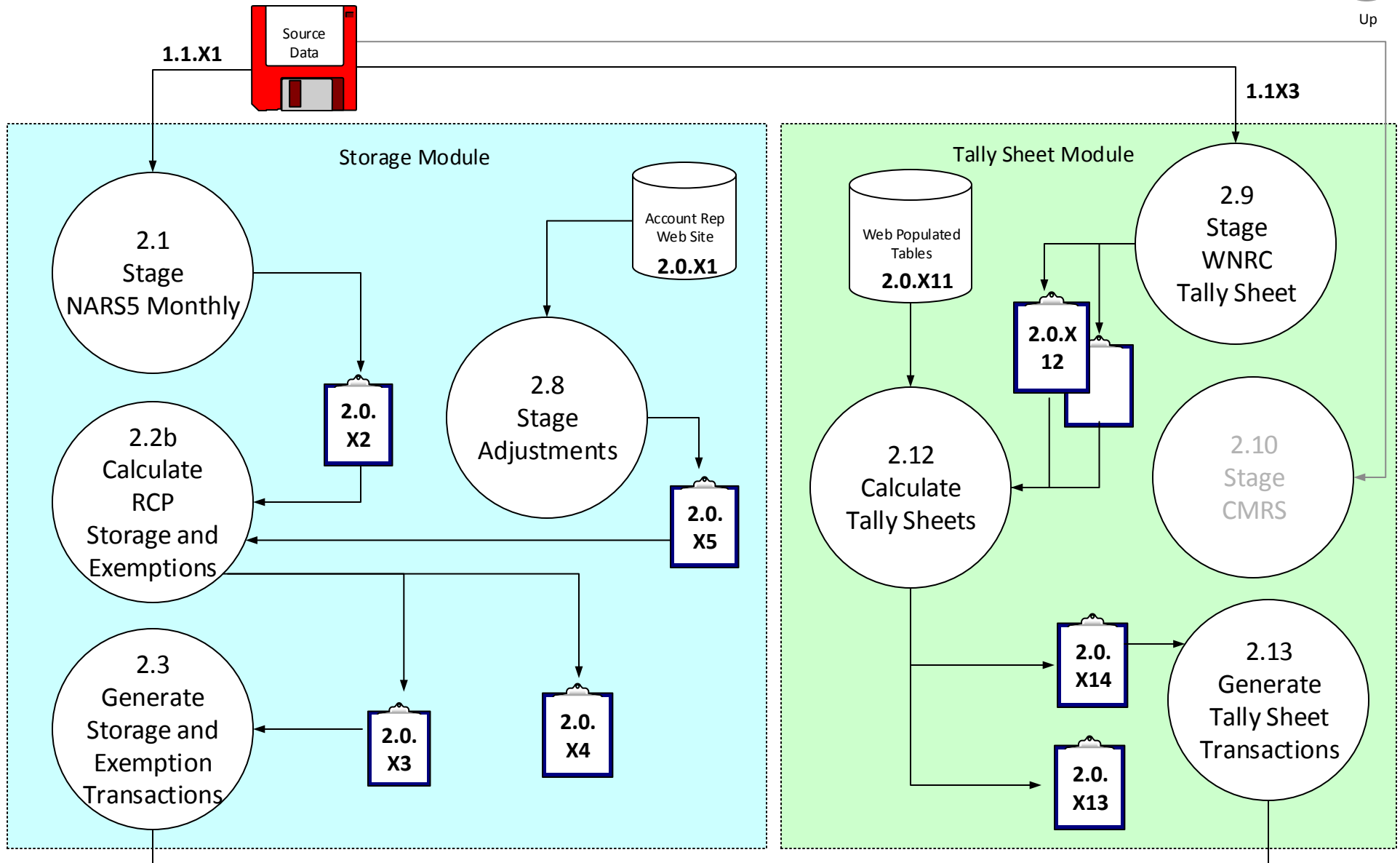

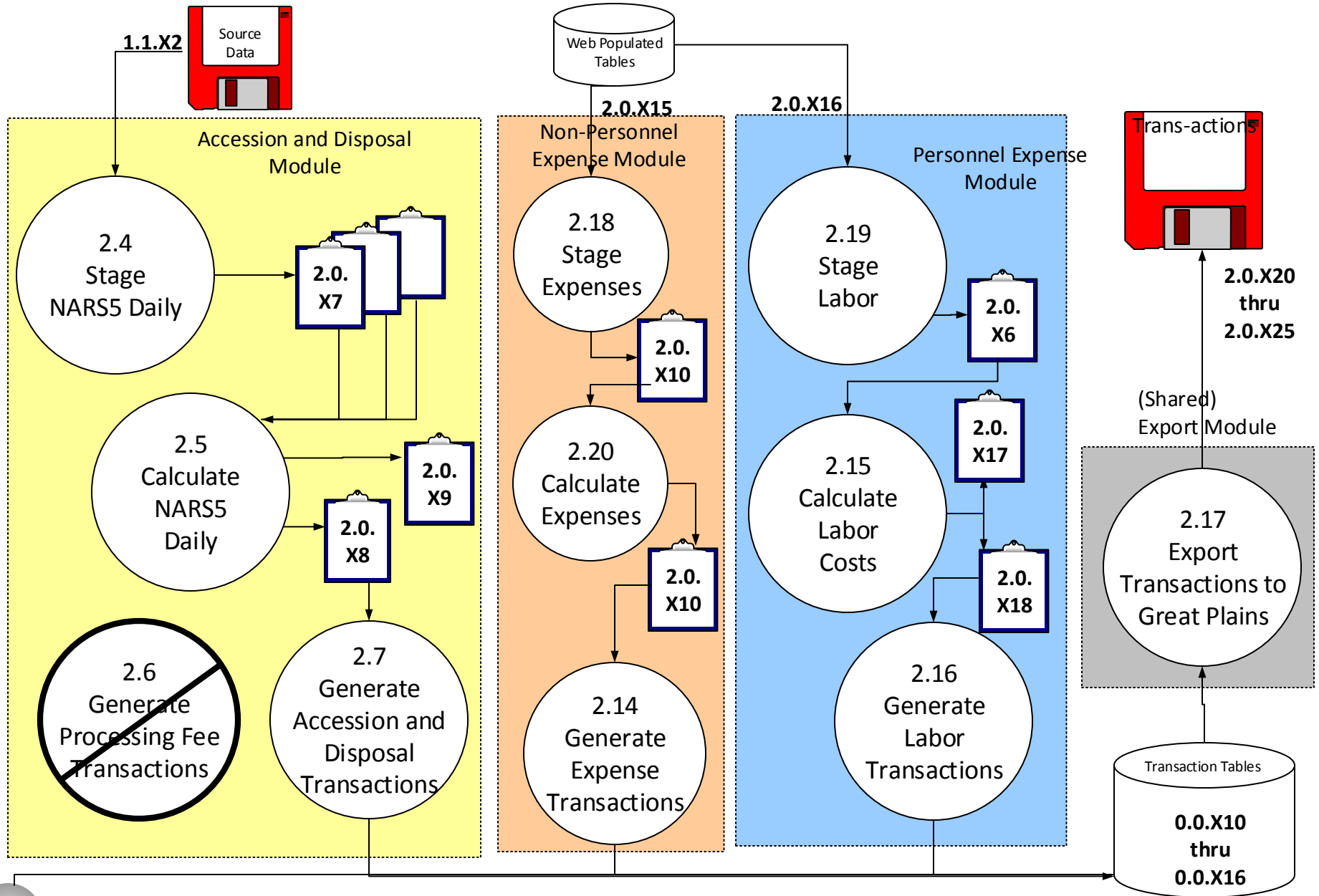

2.1 Stage NARS5 Monthly

v1.0

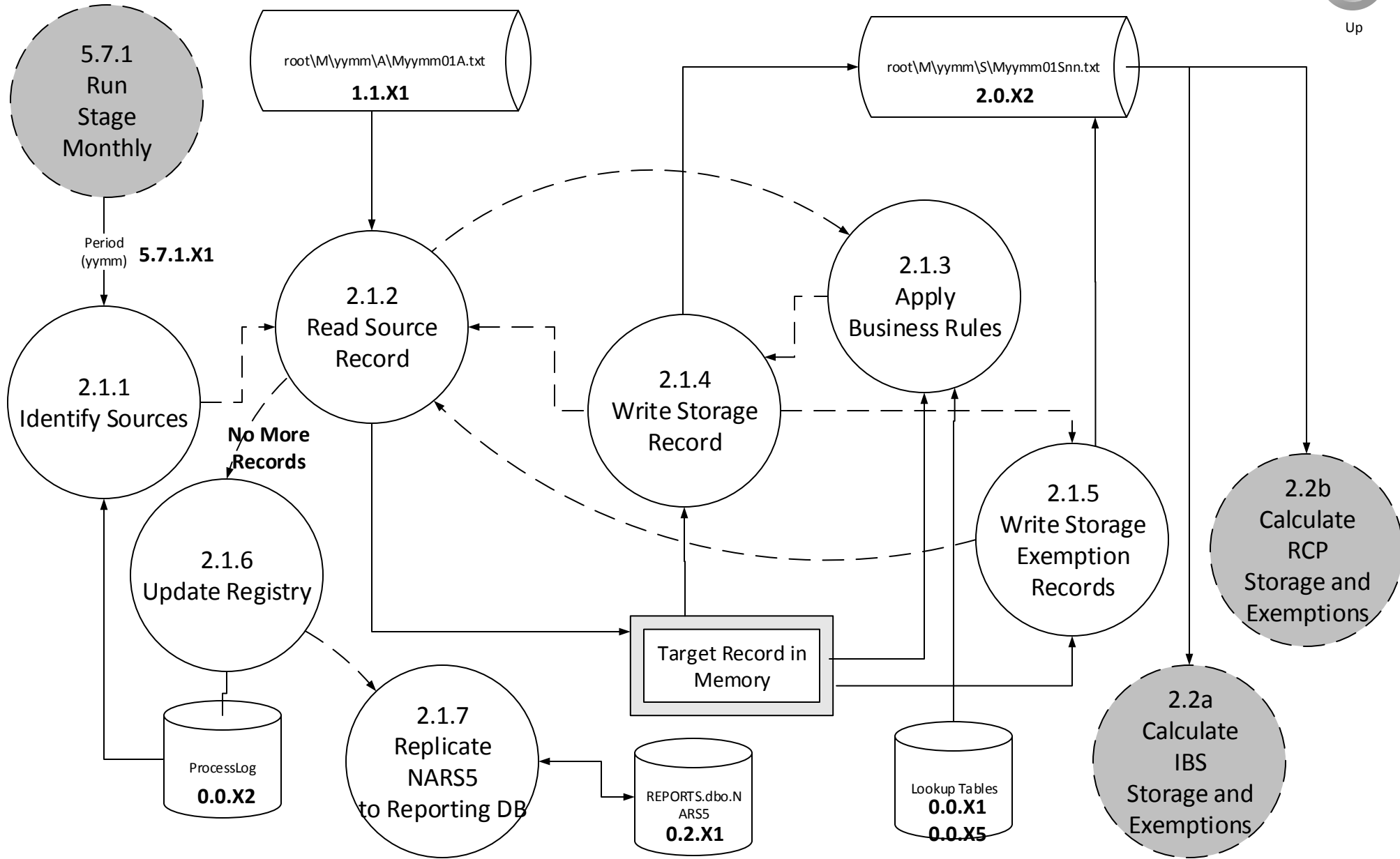

2.2a Calculate IBS Storage and Exemptions

v1.0

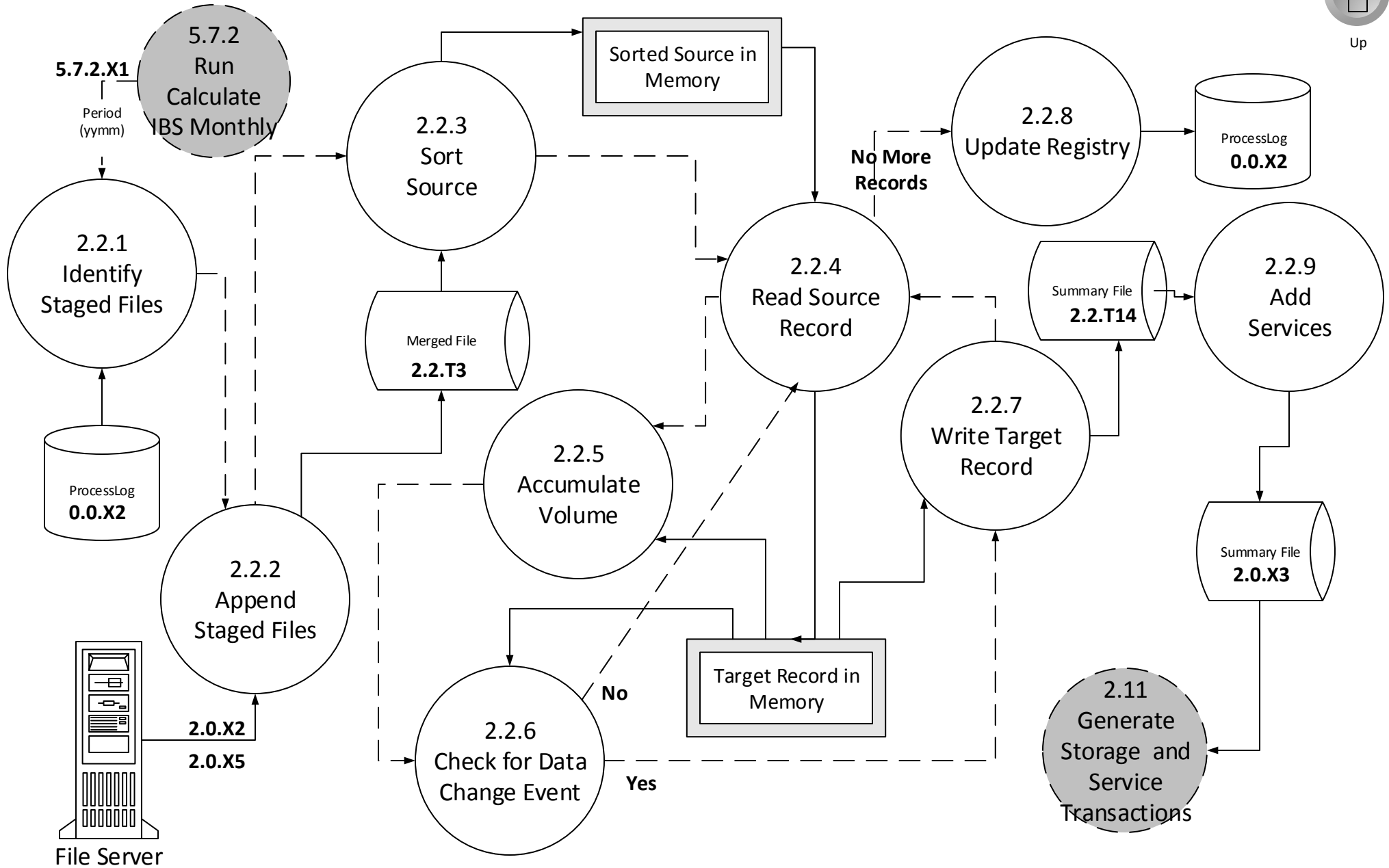

2.2b Calculate RCP Storage and Exemptions

v4.3



Up

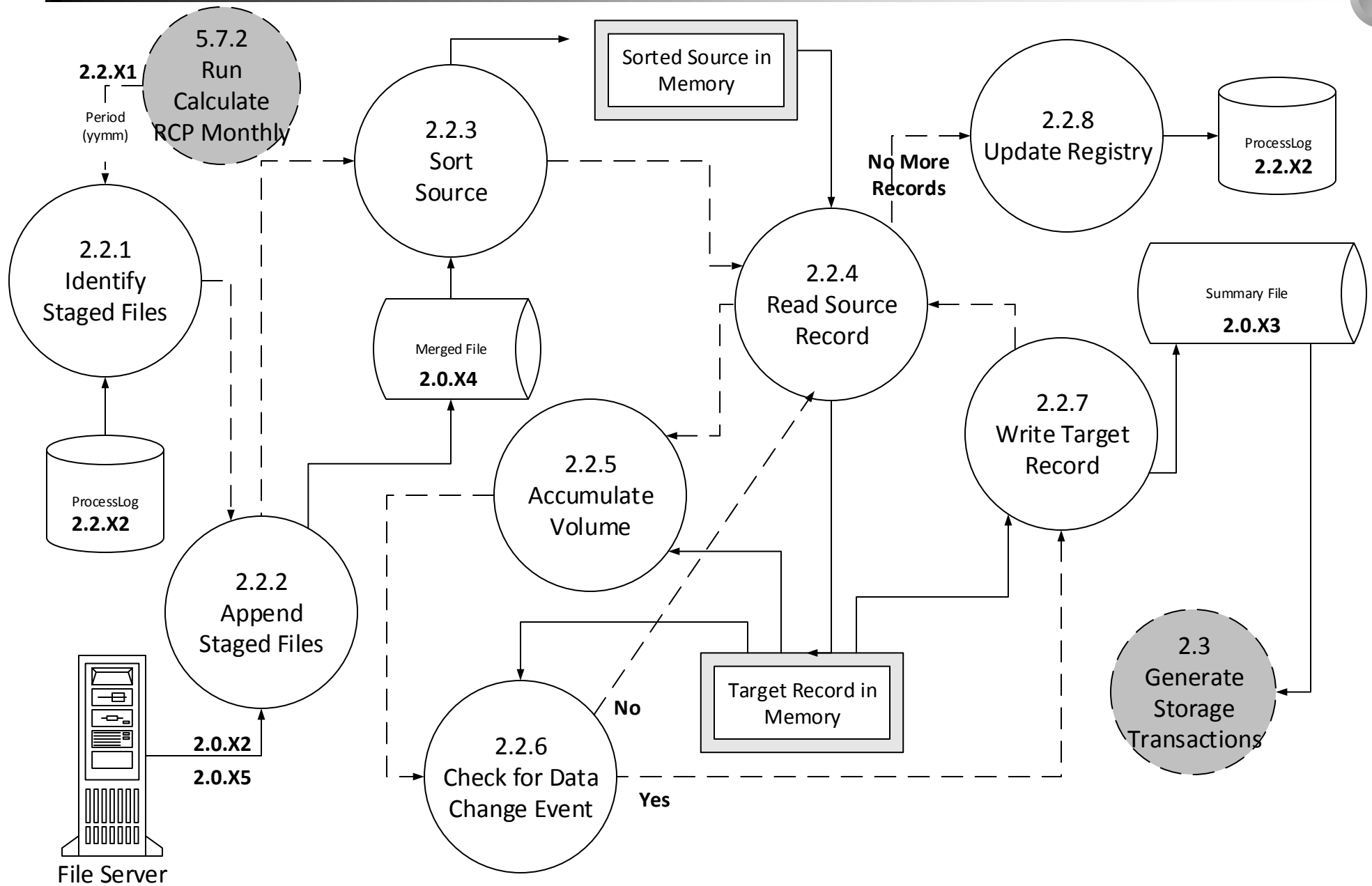

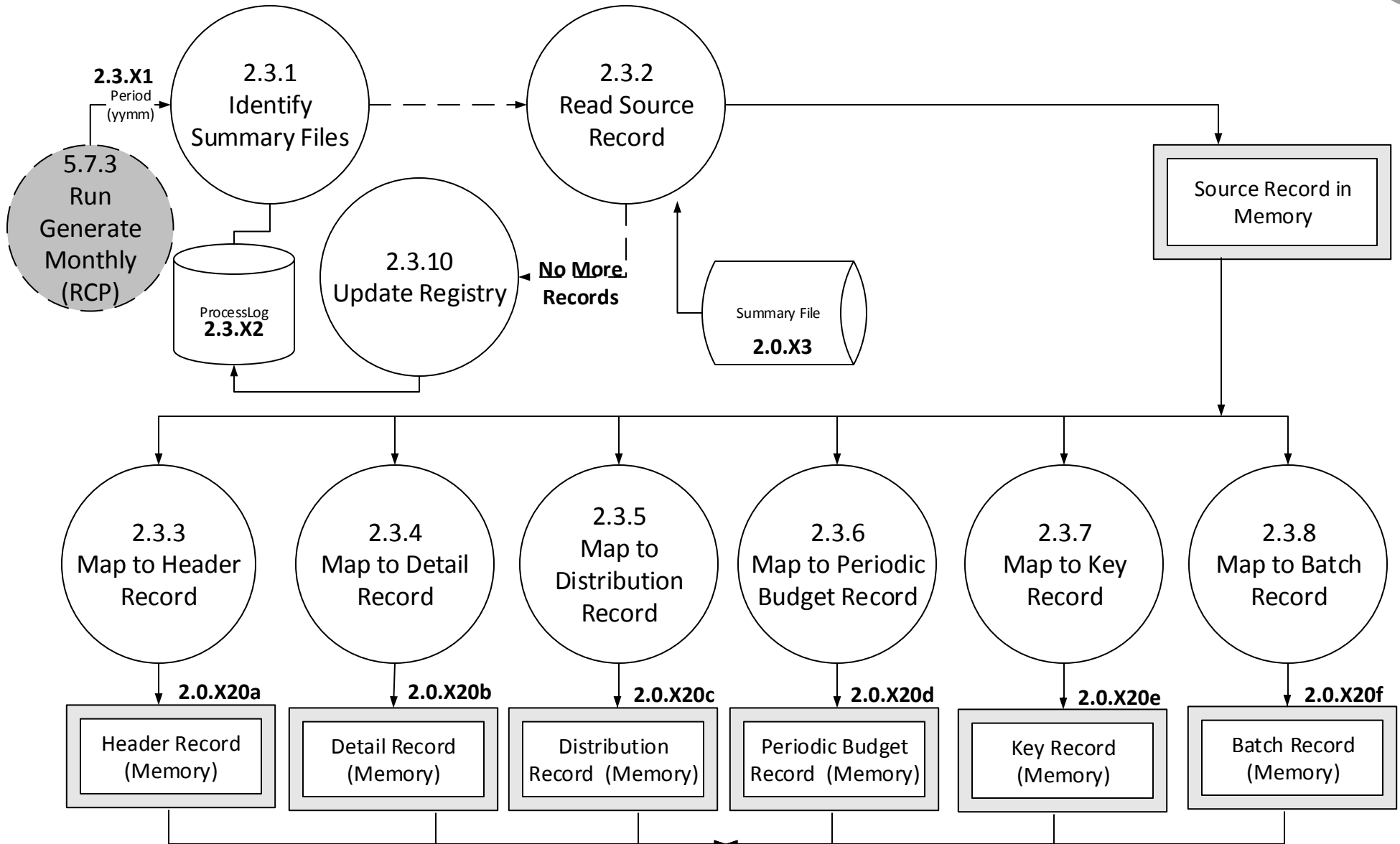

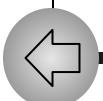
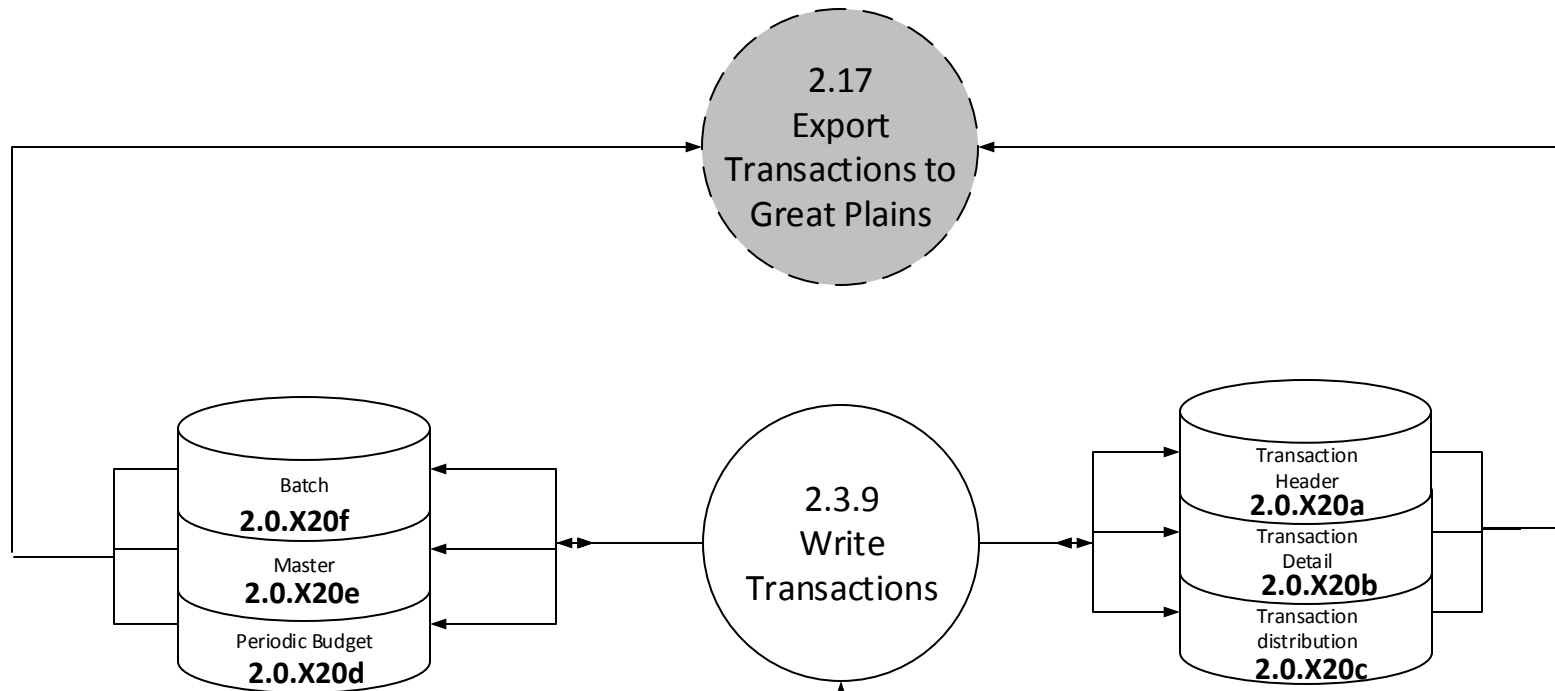

2.4 Stage NARS5 Daily

v1.0



Up

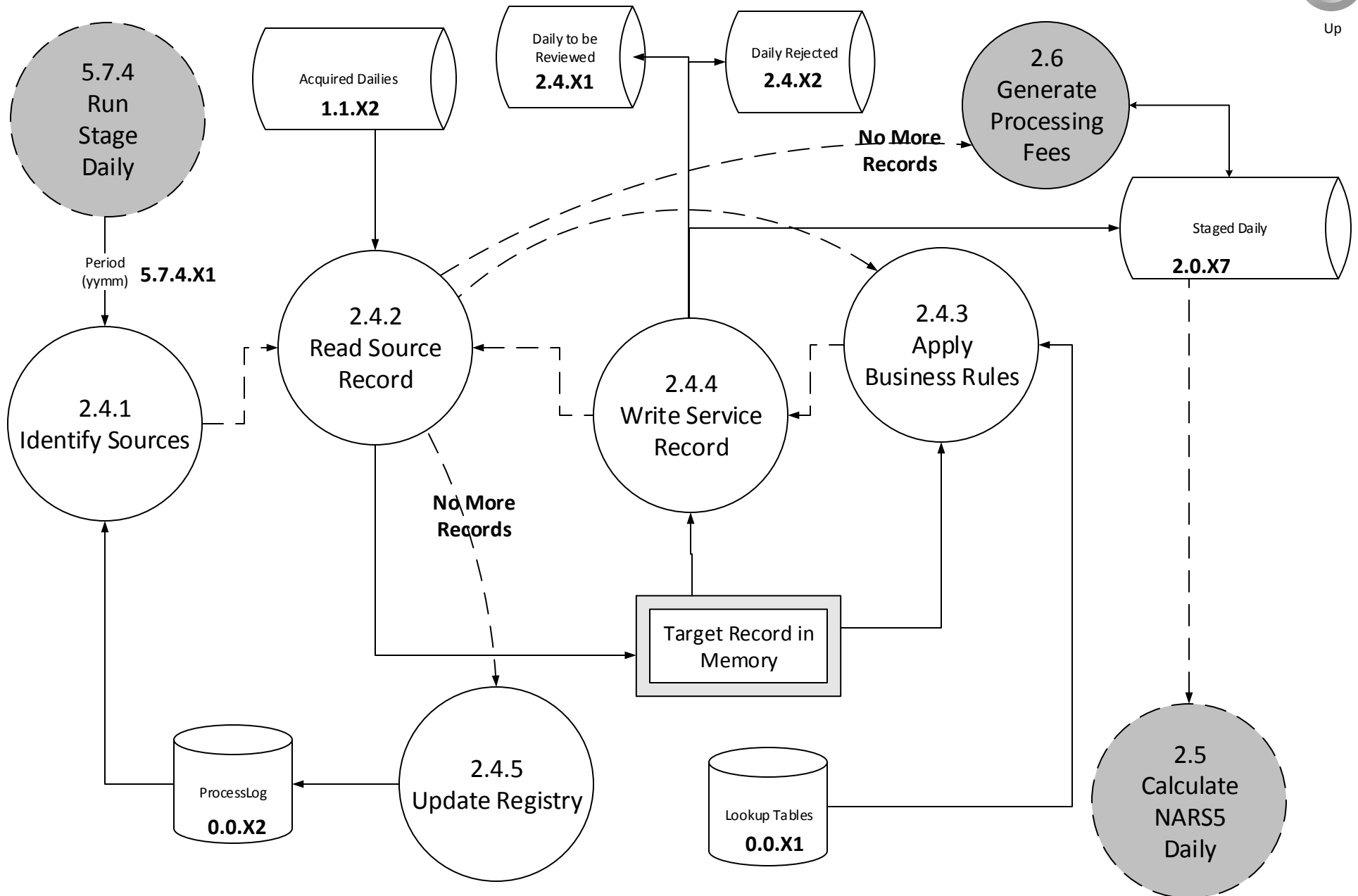

2.5 Calculate Daily NARS5

v1.0

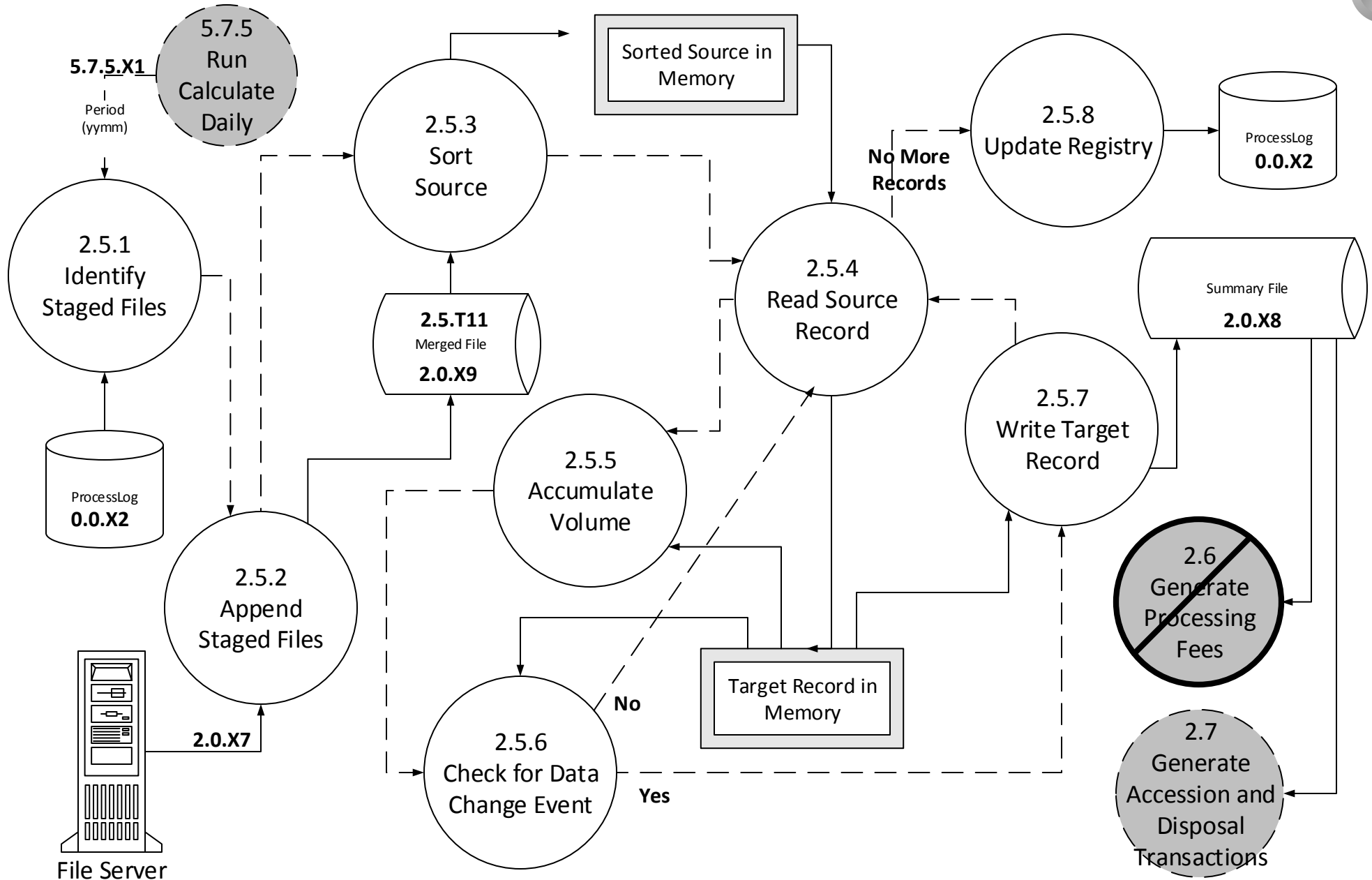

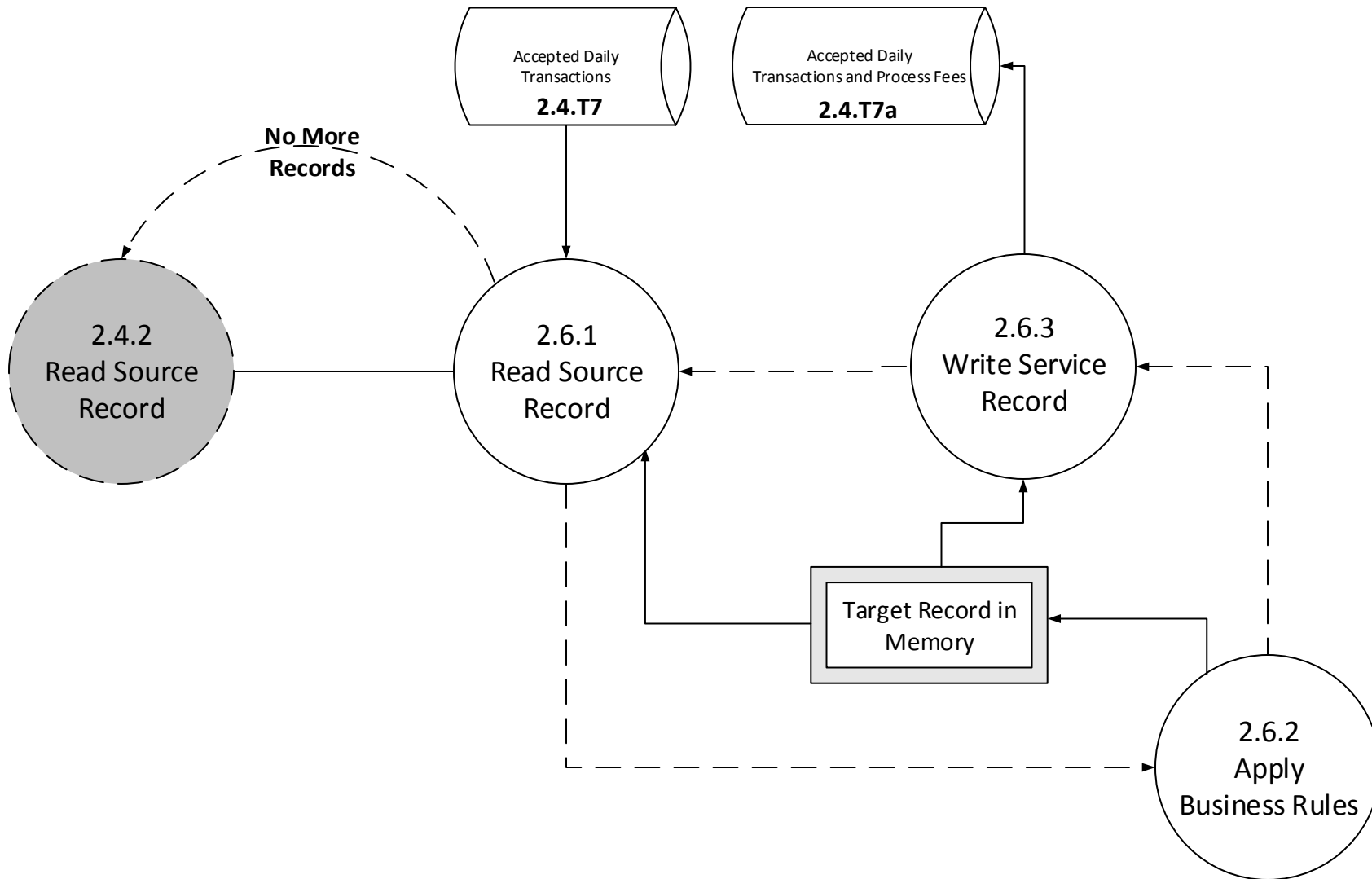

2.7 Generate Accession and Disposal Transactions

v1.0

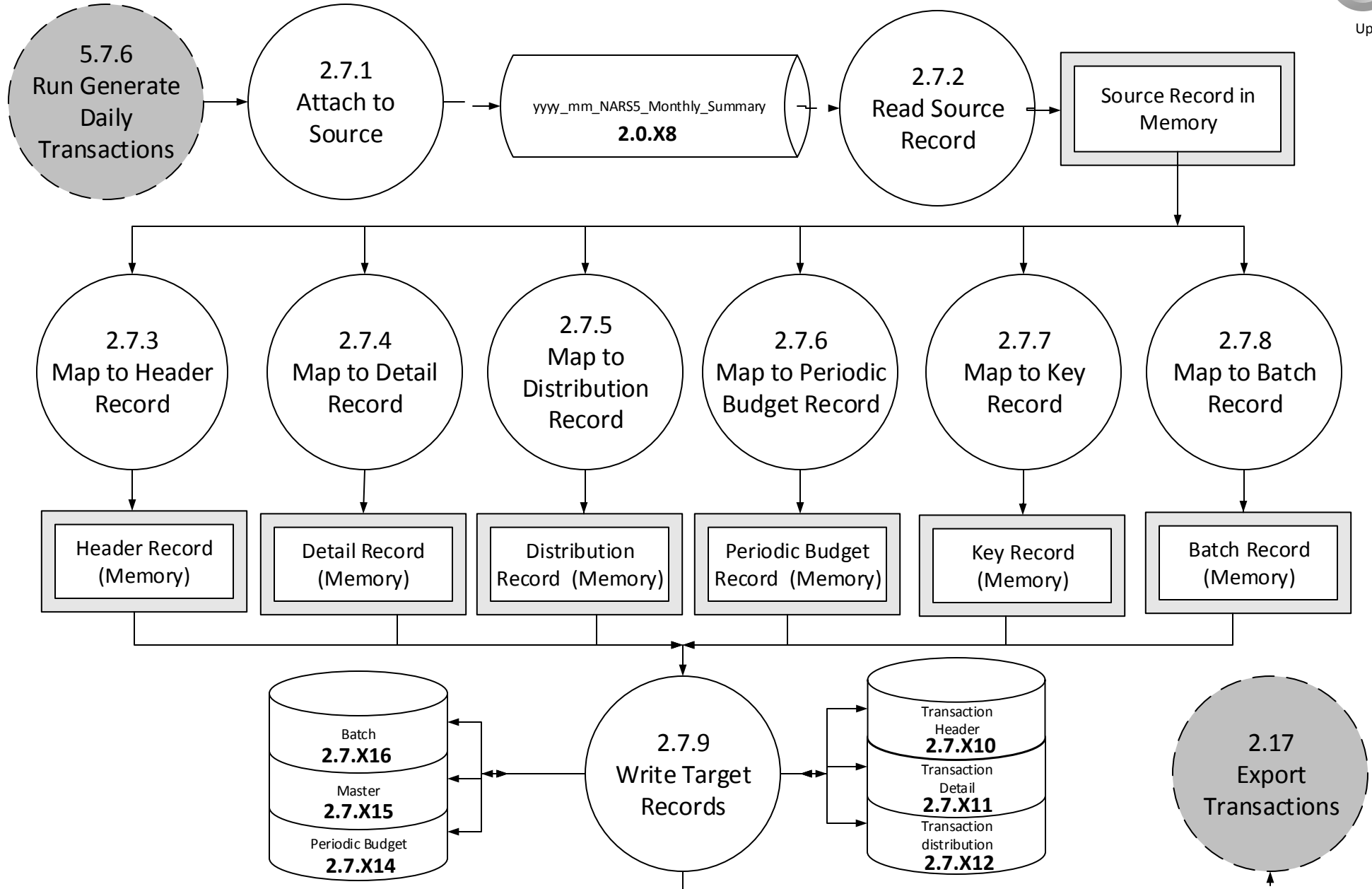

2.8 Stage Adjustments

v1.0

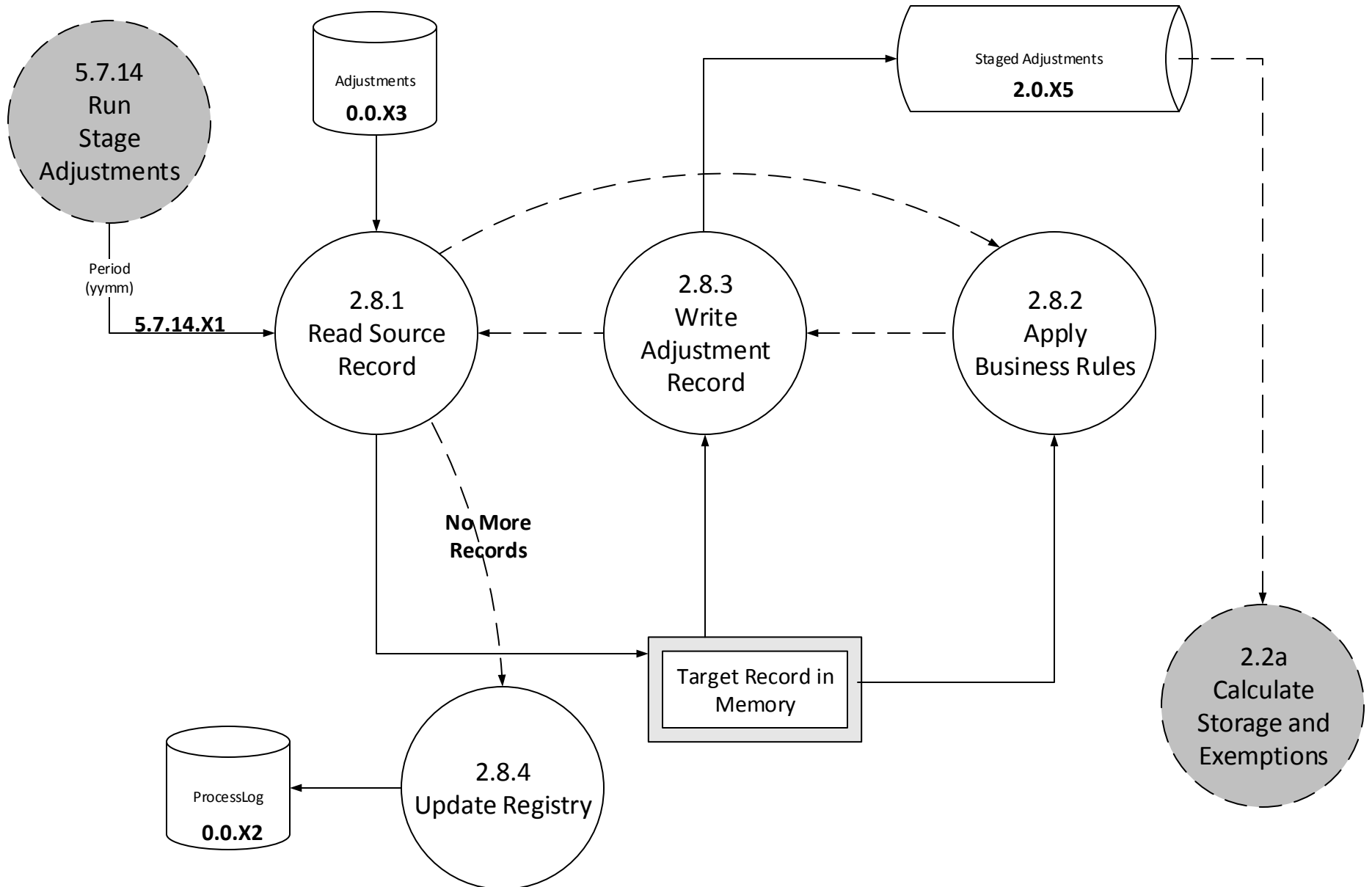

2.9 Stage WNRC Tally Sheets

v4.3



Up

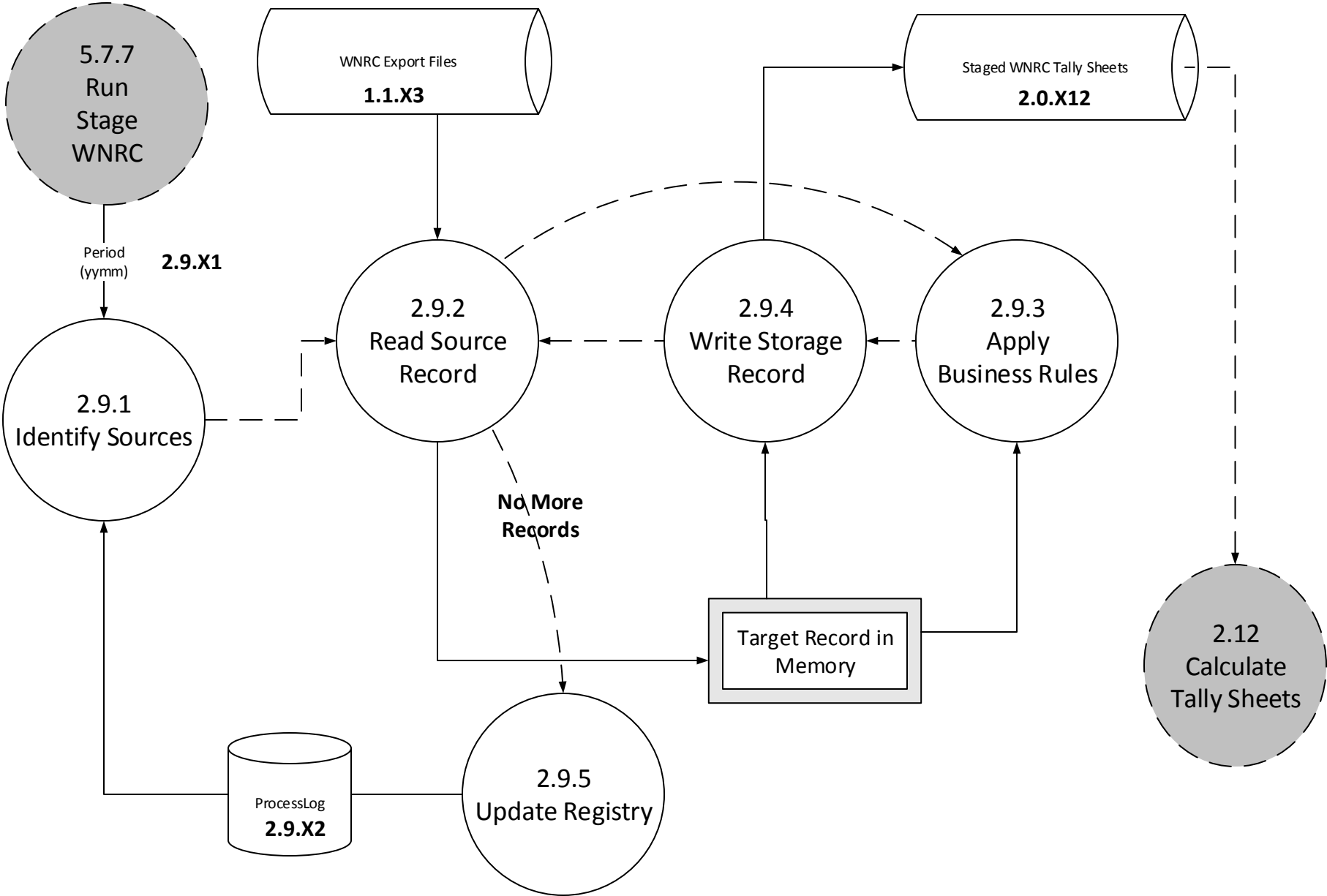

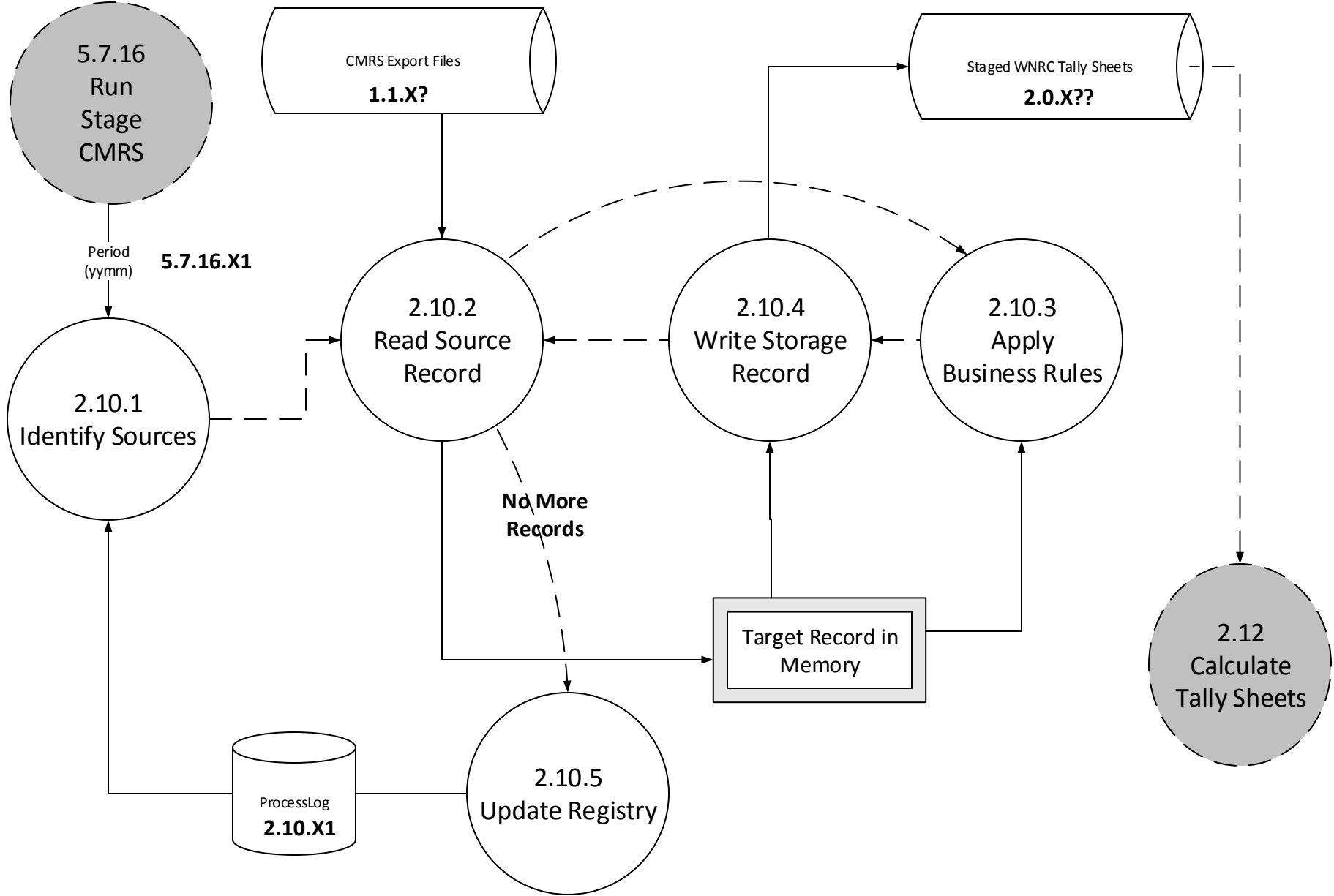

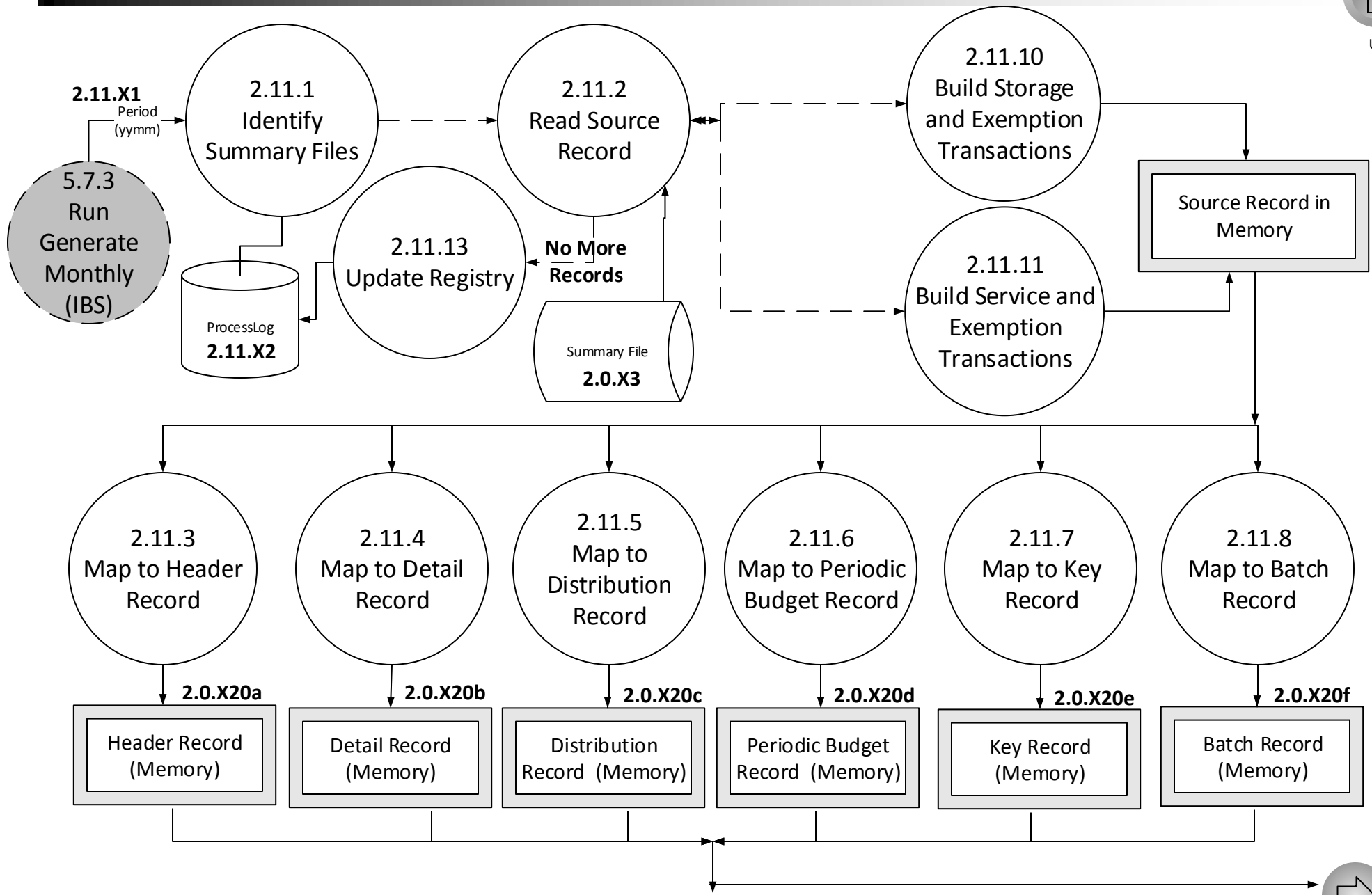

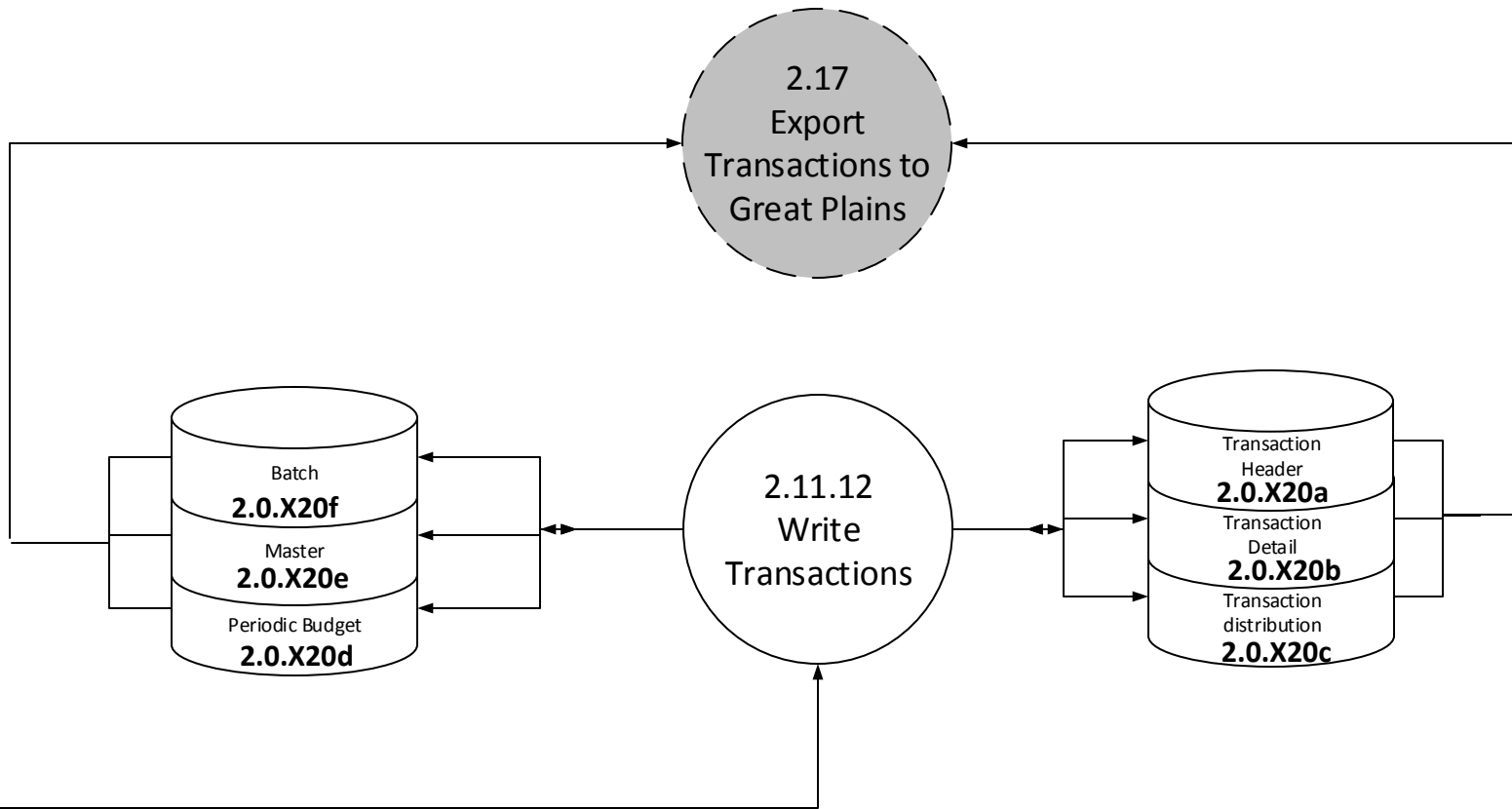

2.12 Calculate Tally Sheets

v4.3



Up

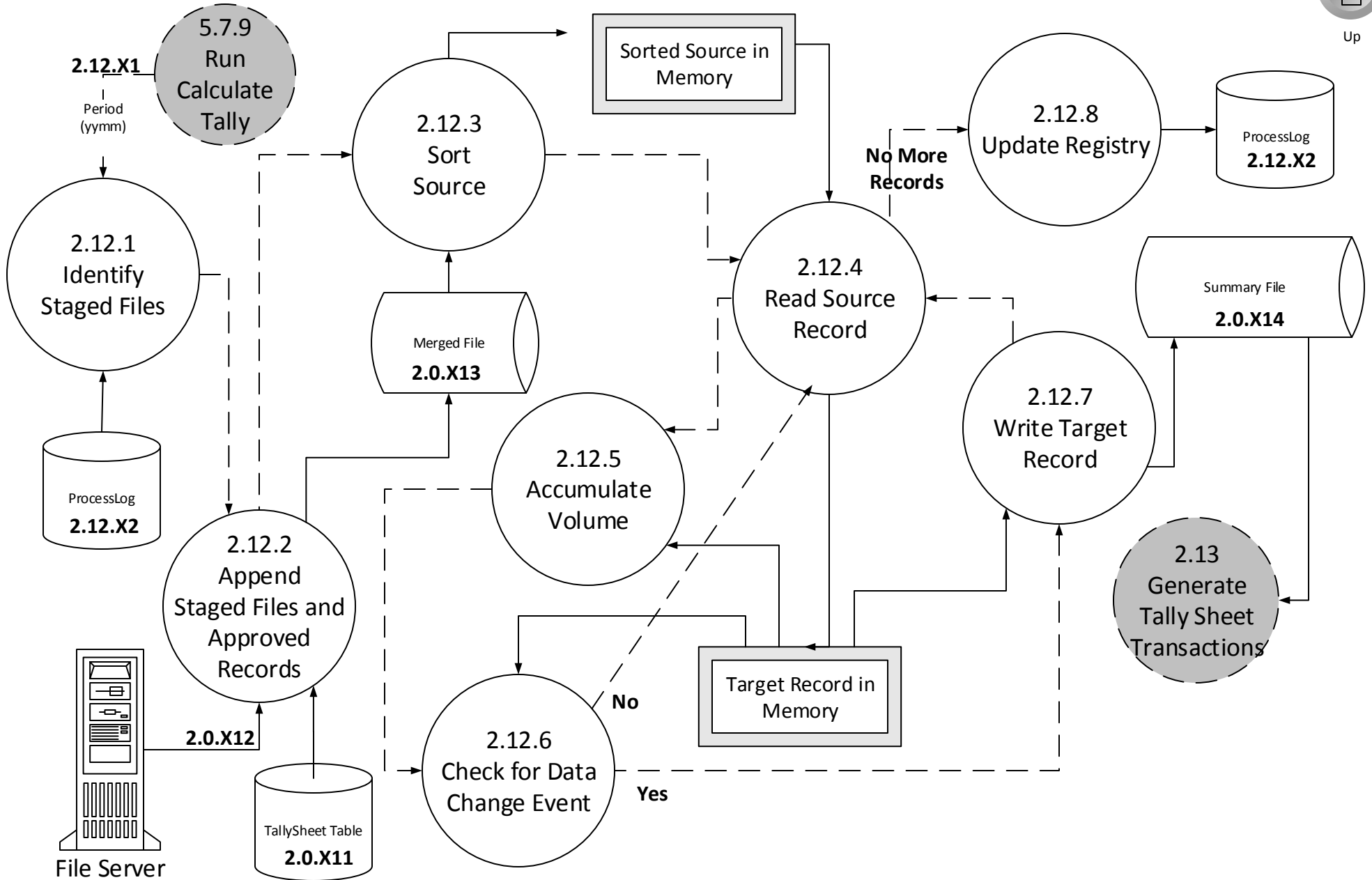



Up

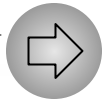
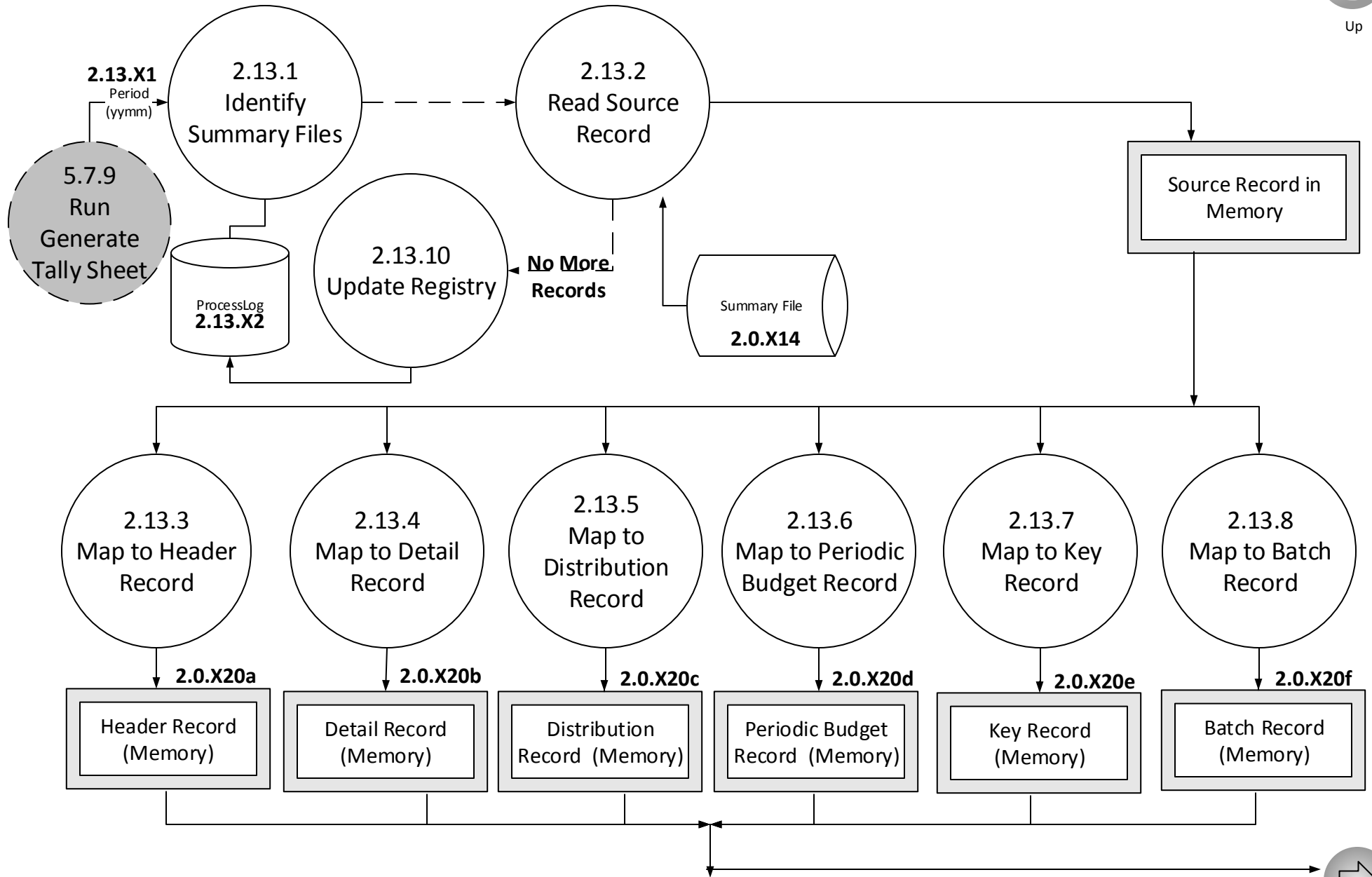

Next Page



Up

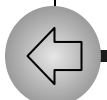
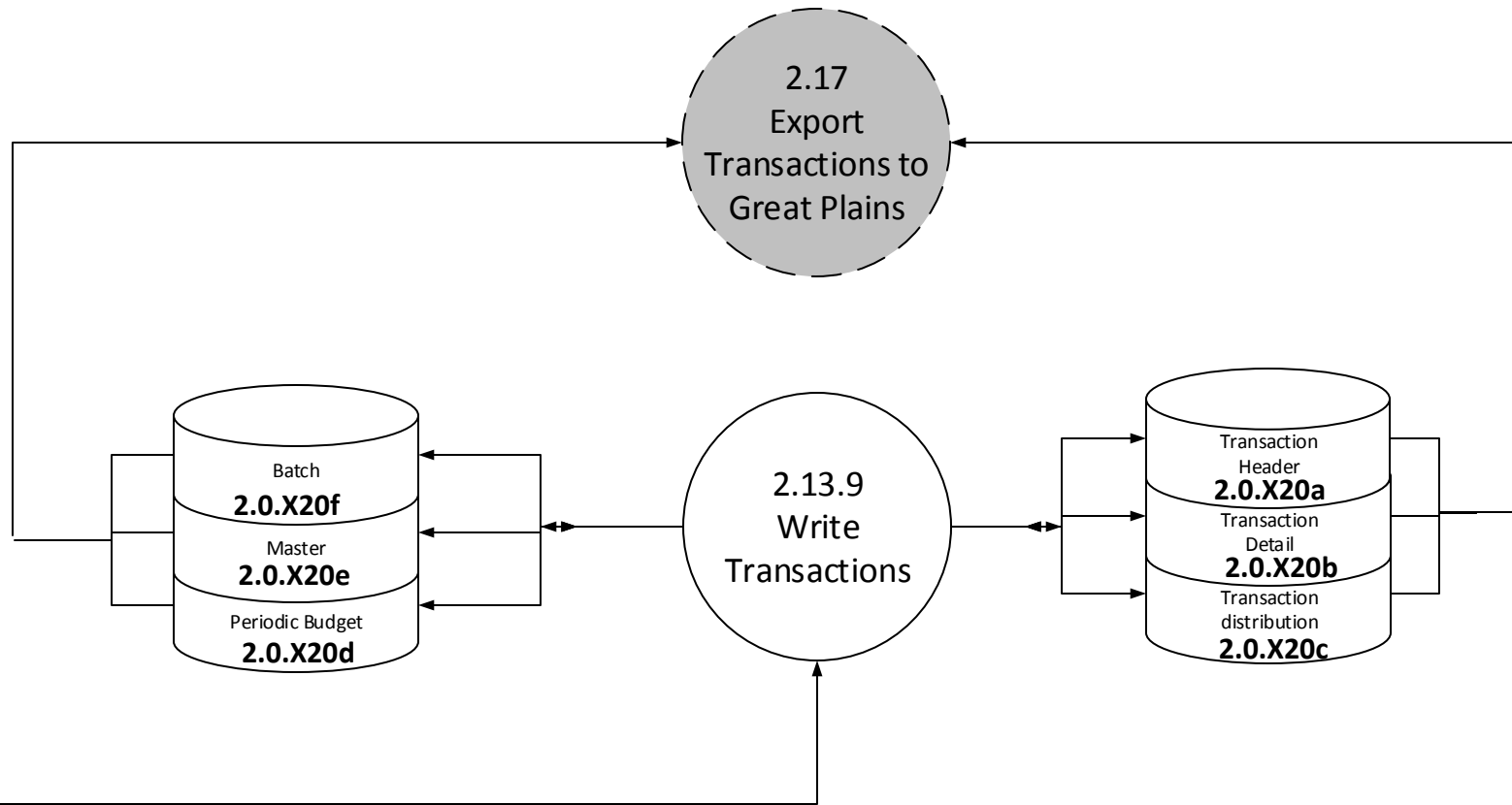

Previous Page

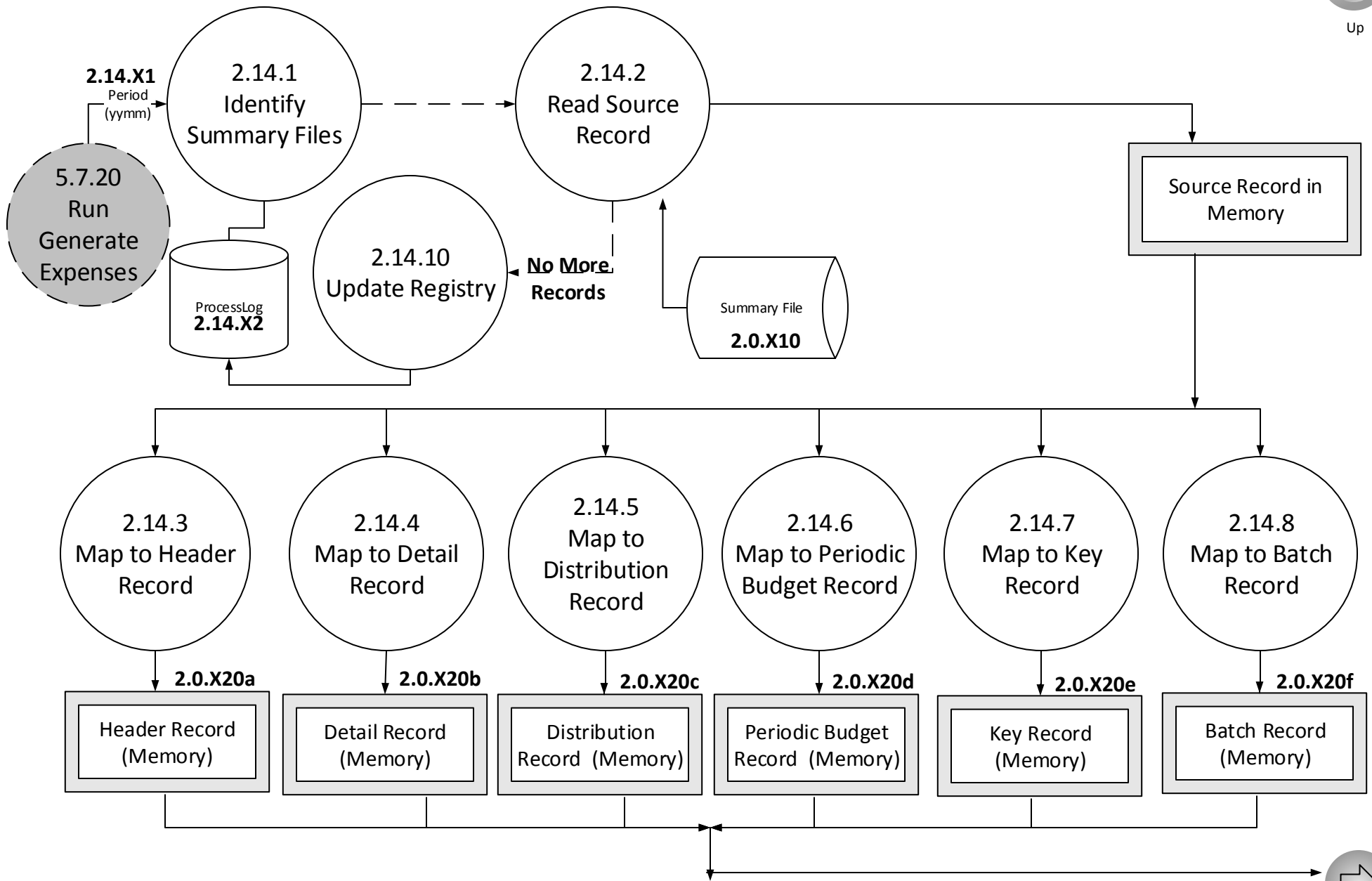

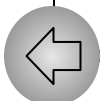
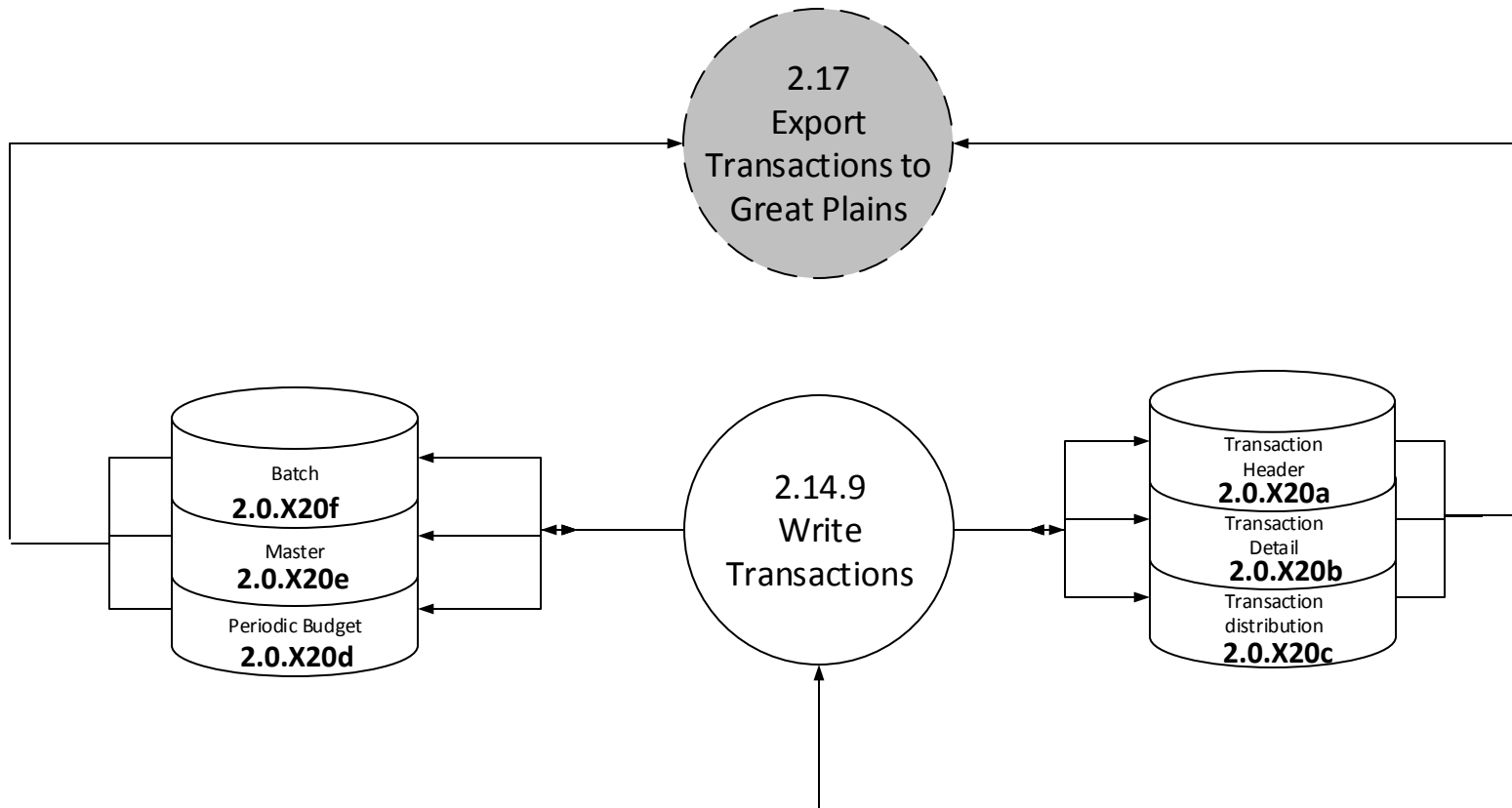

2.15 Calculate Labor Costs

v4.3

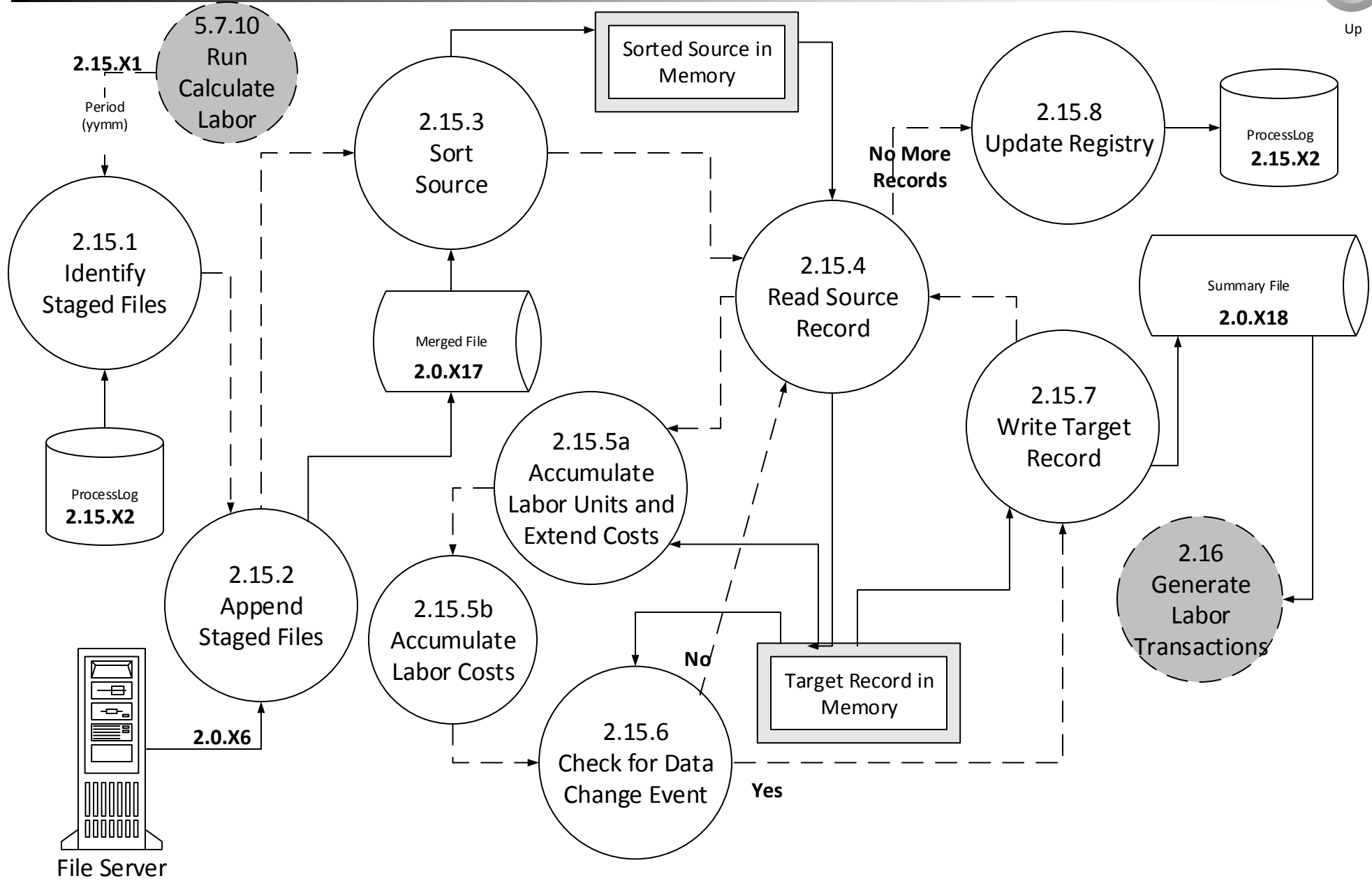



Up

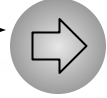
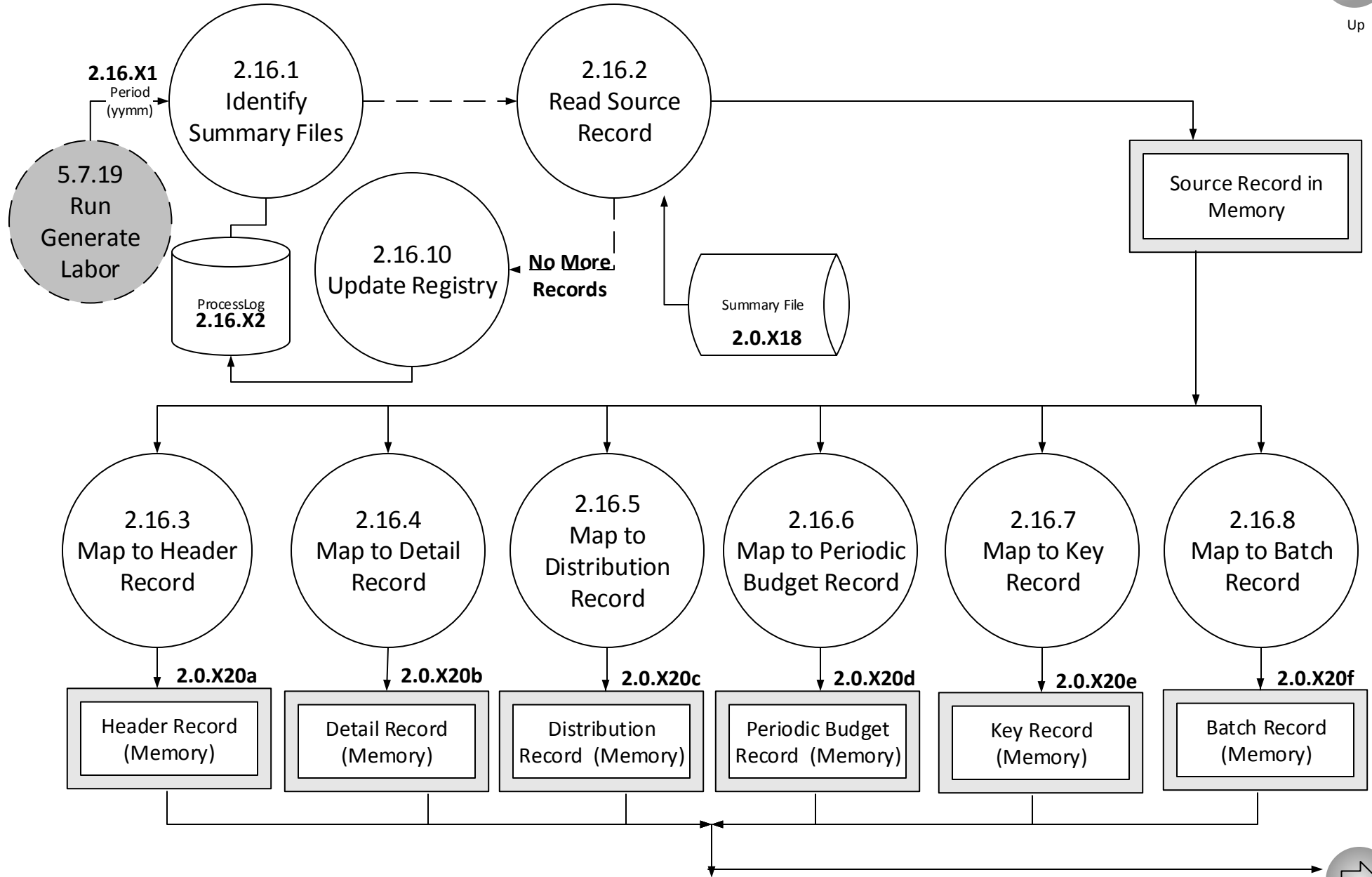

Next Page

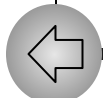
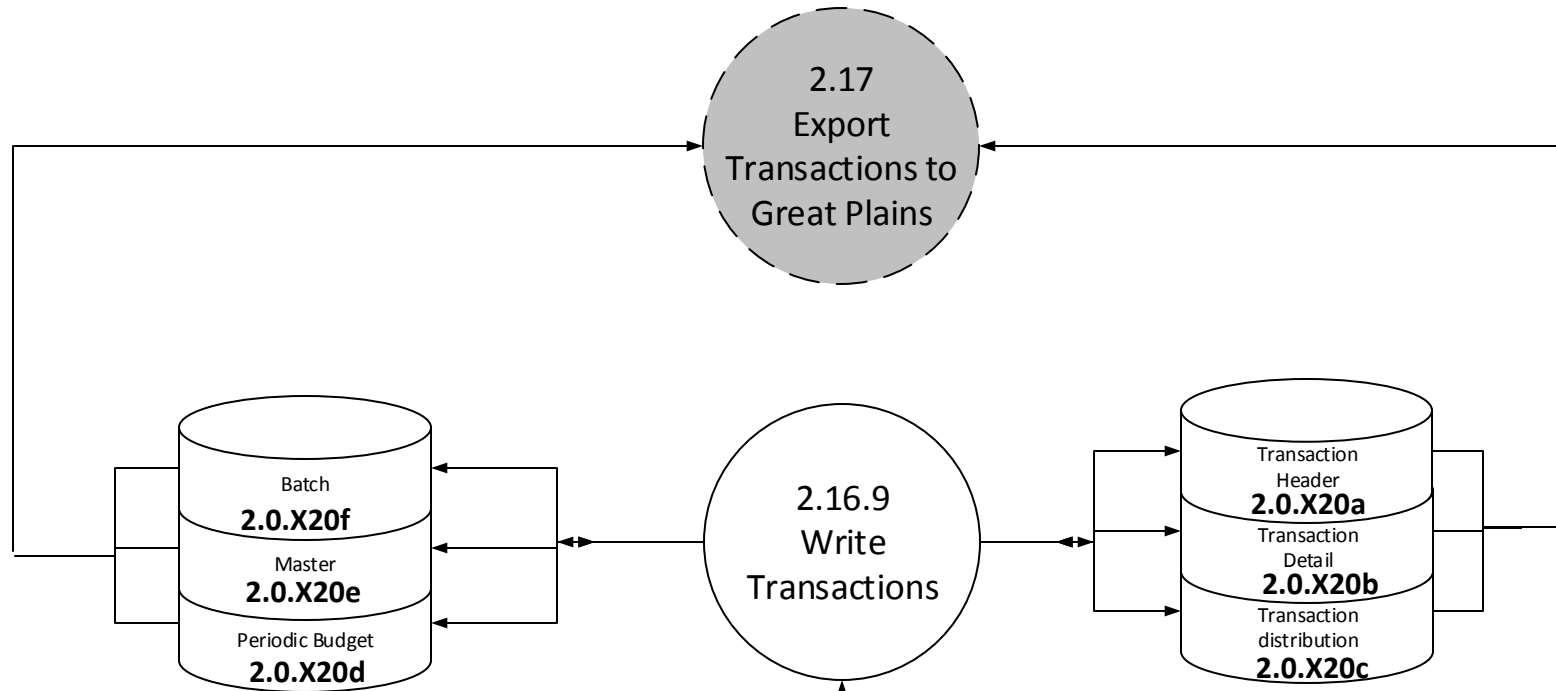

2.17 Export Transactions

v1.0



Up

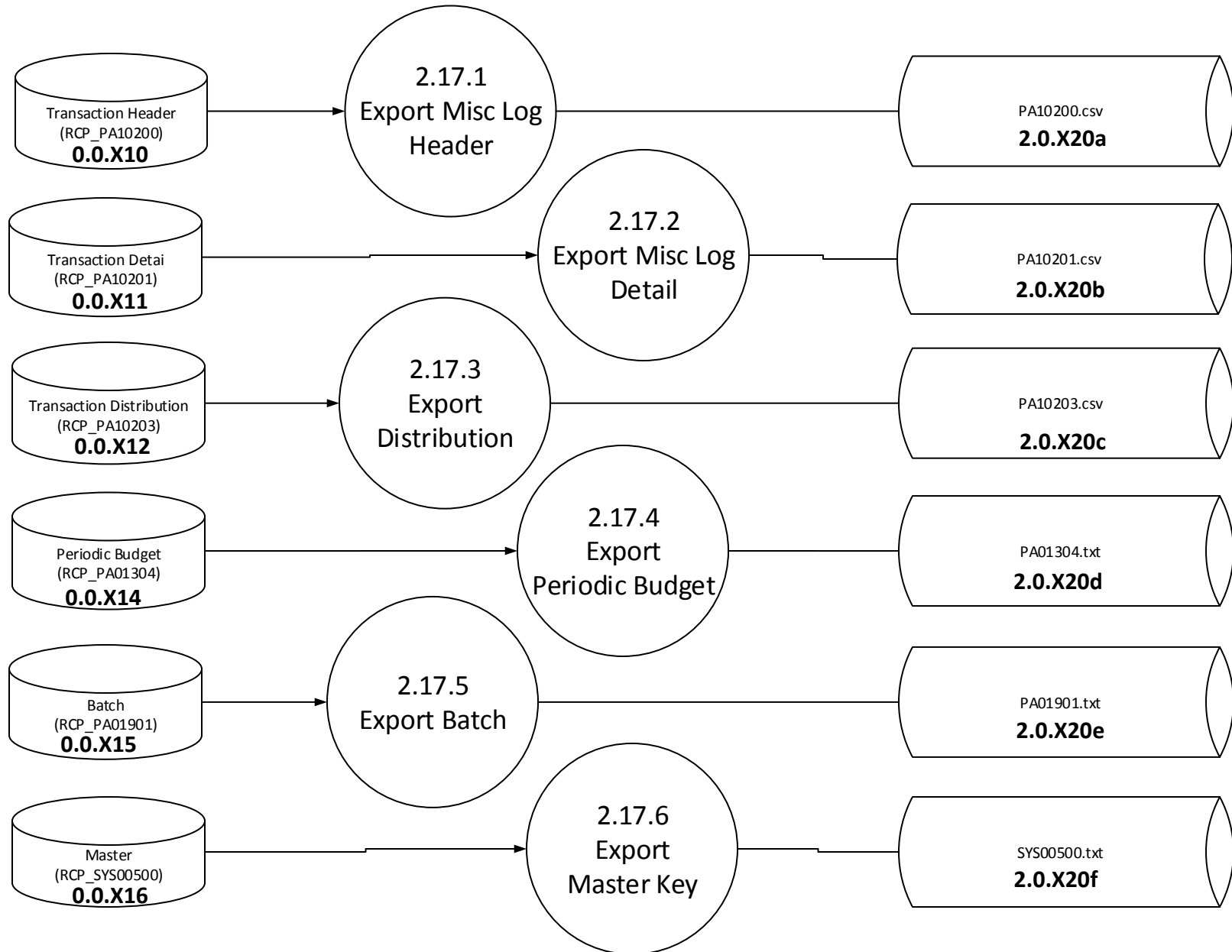

2.18 Stage Expenses

v4.3

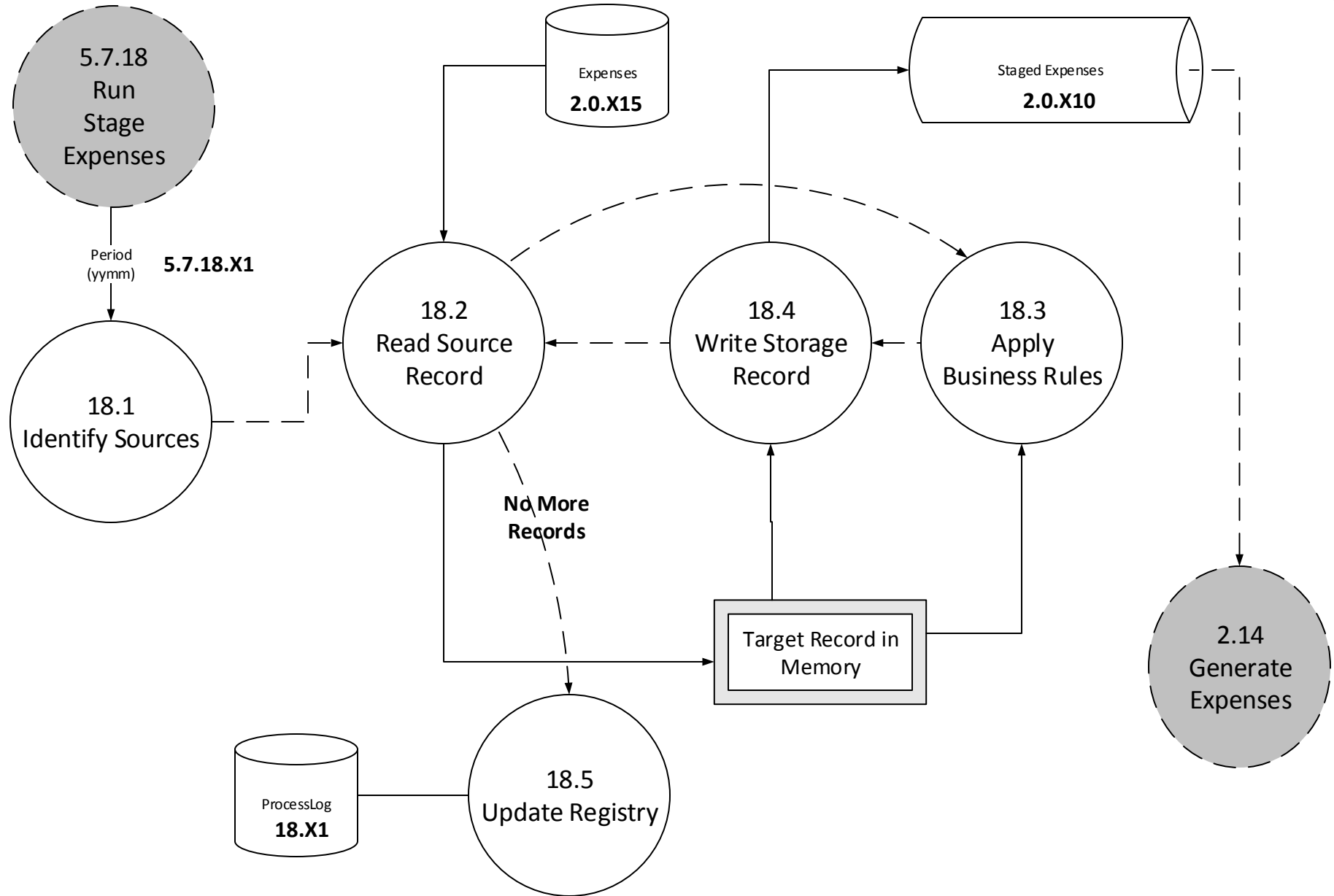

2.19 Stage Labor

v4.3

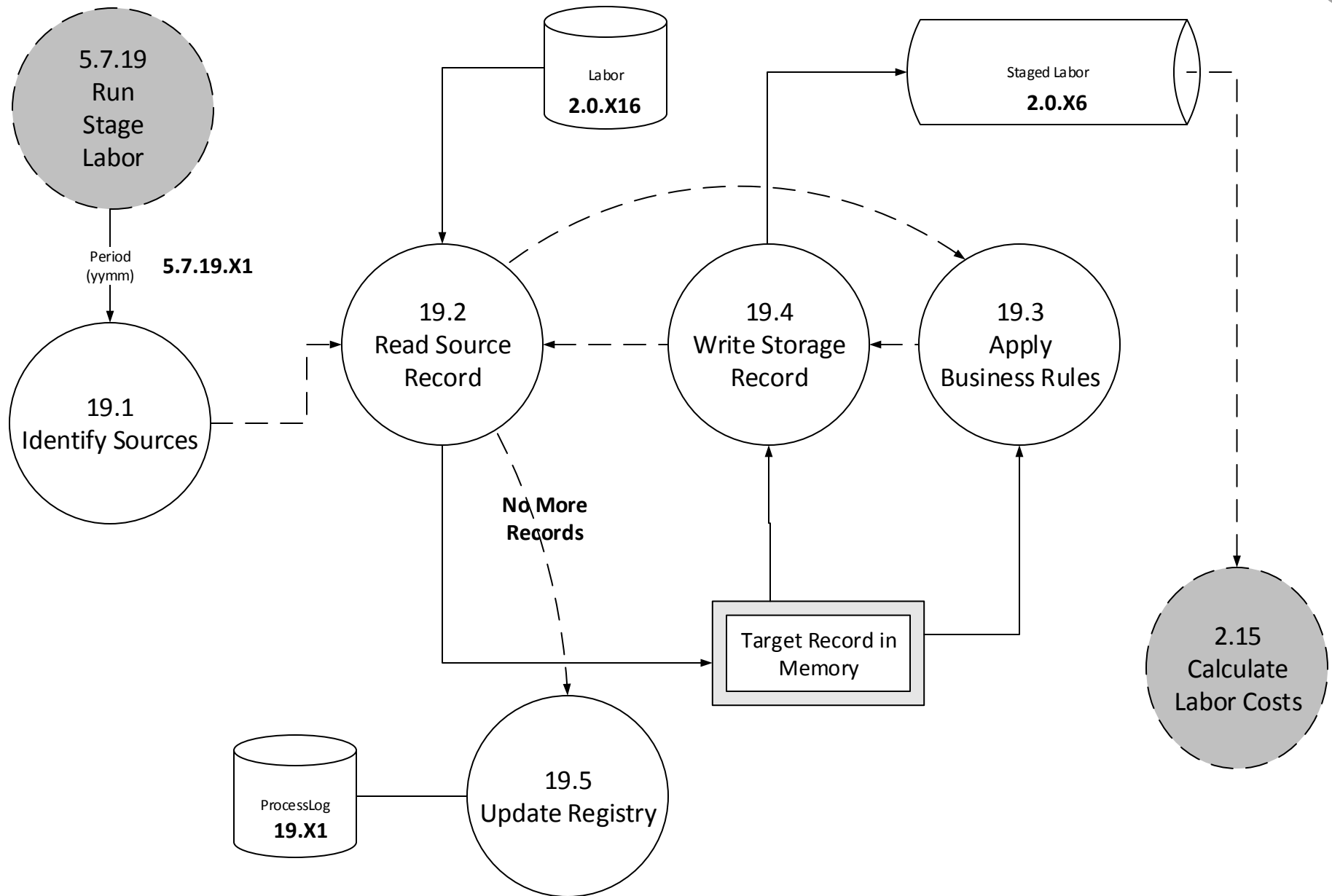

3.0 Great Plains Accounting

v4.3

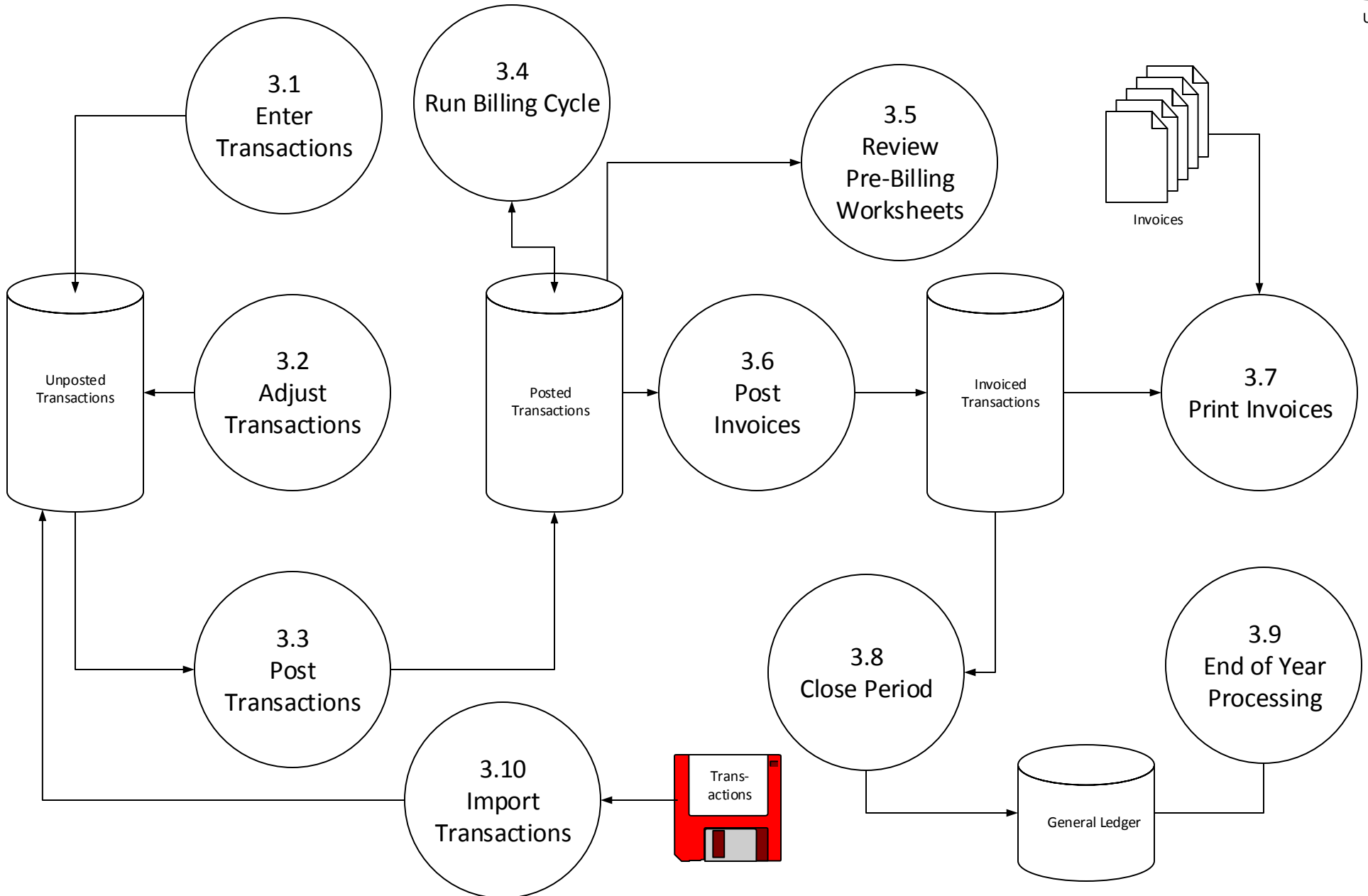

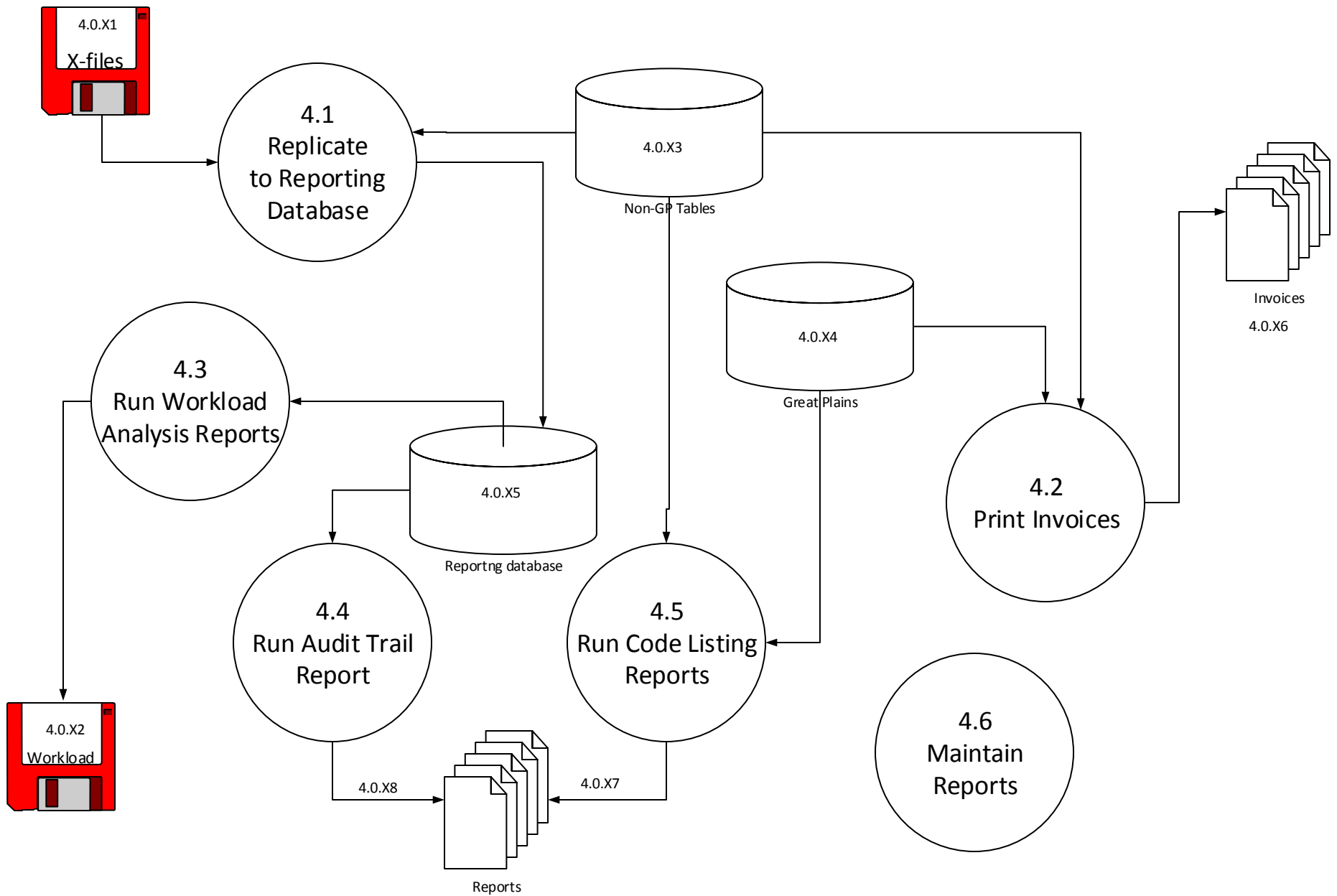

4.1 Replicate Data to Reporting Database

v4.4

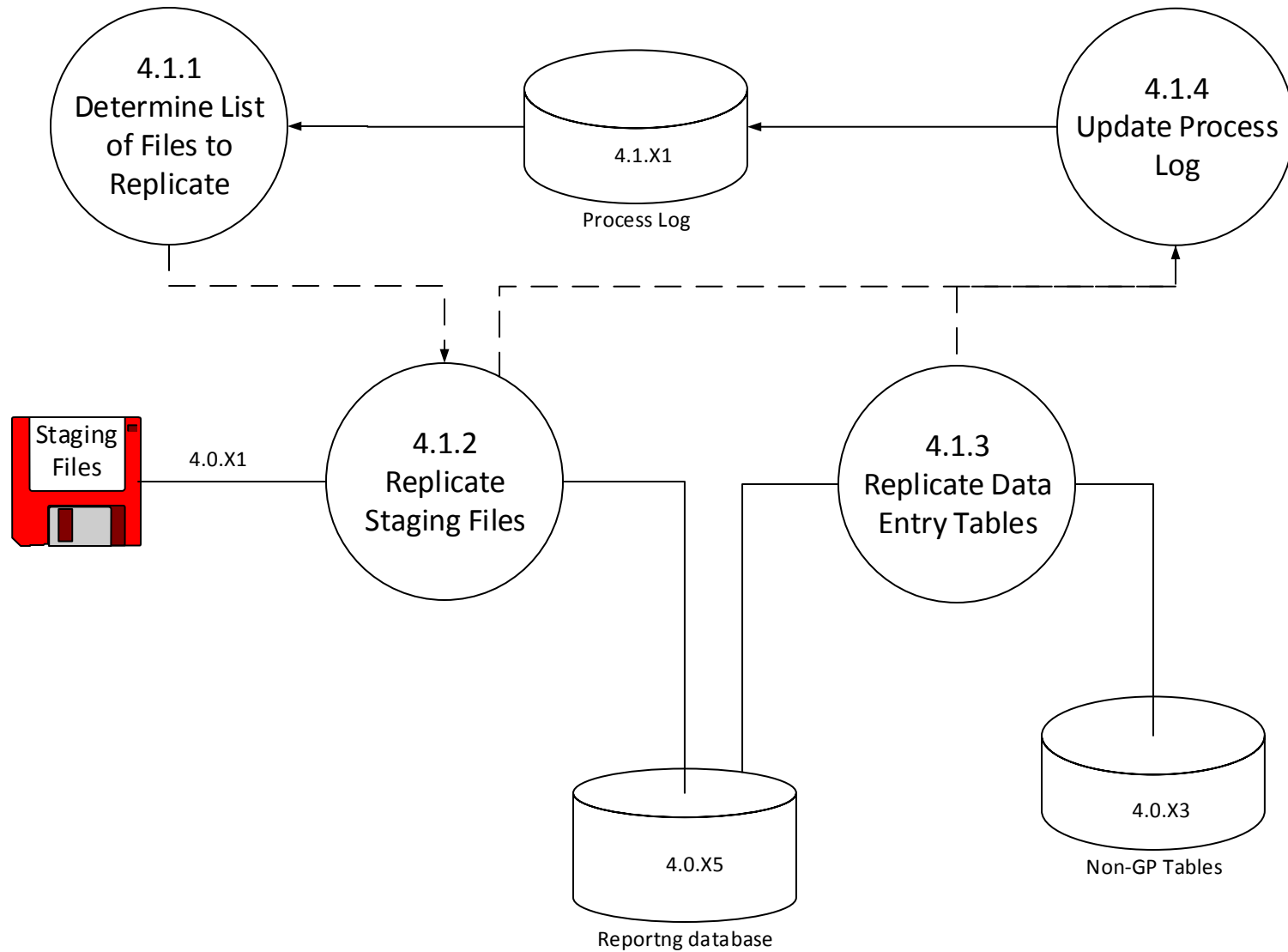

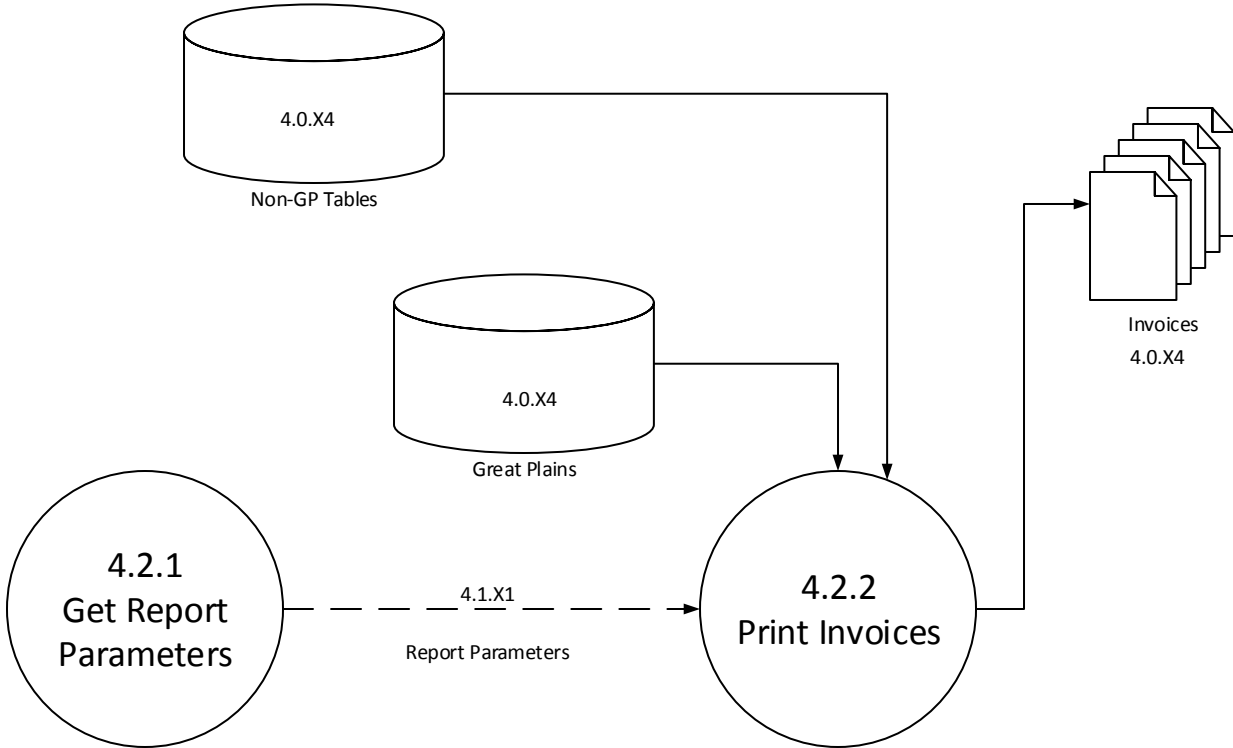

4.3 Run Workload Analysis Reports

v4.4

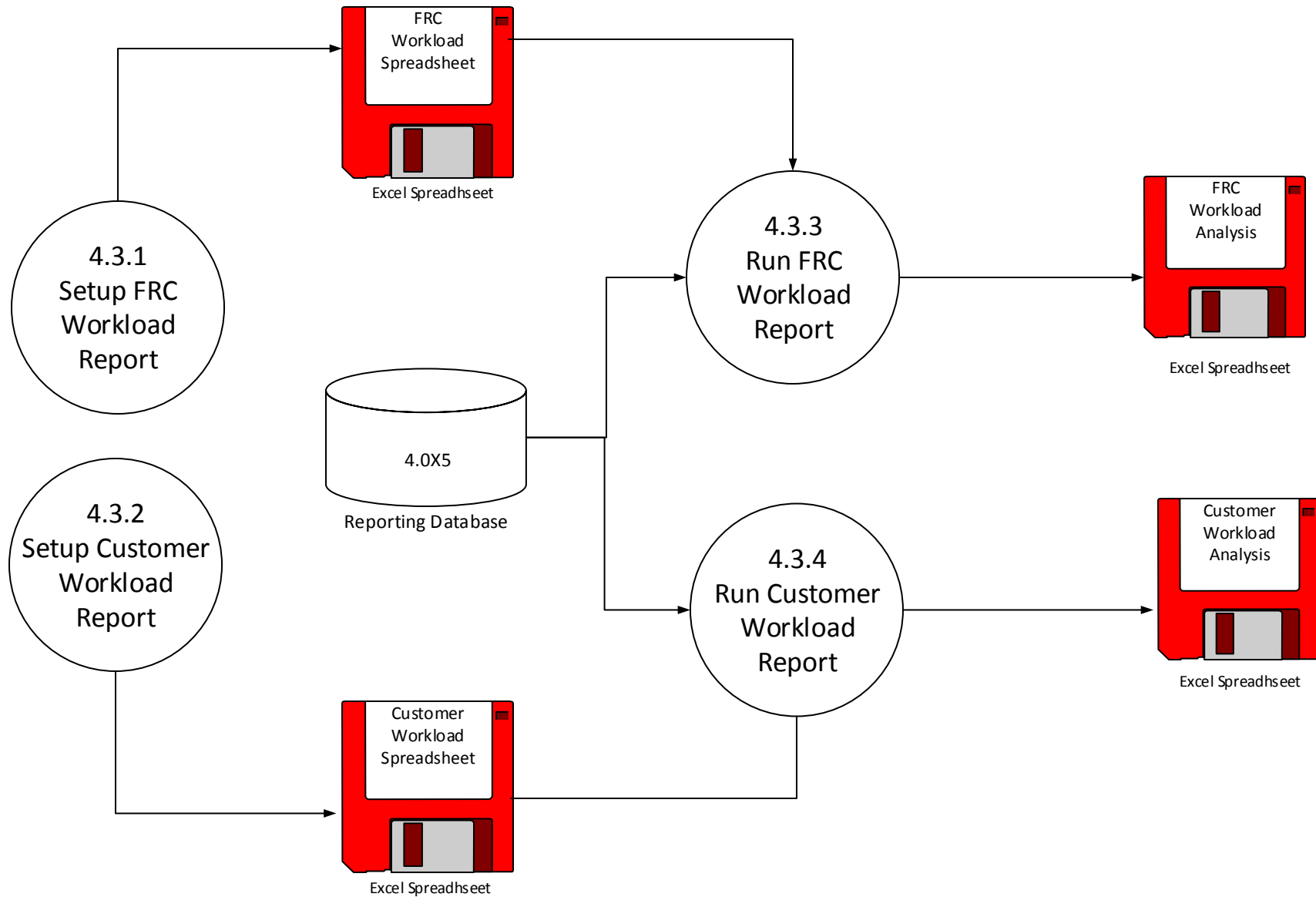

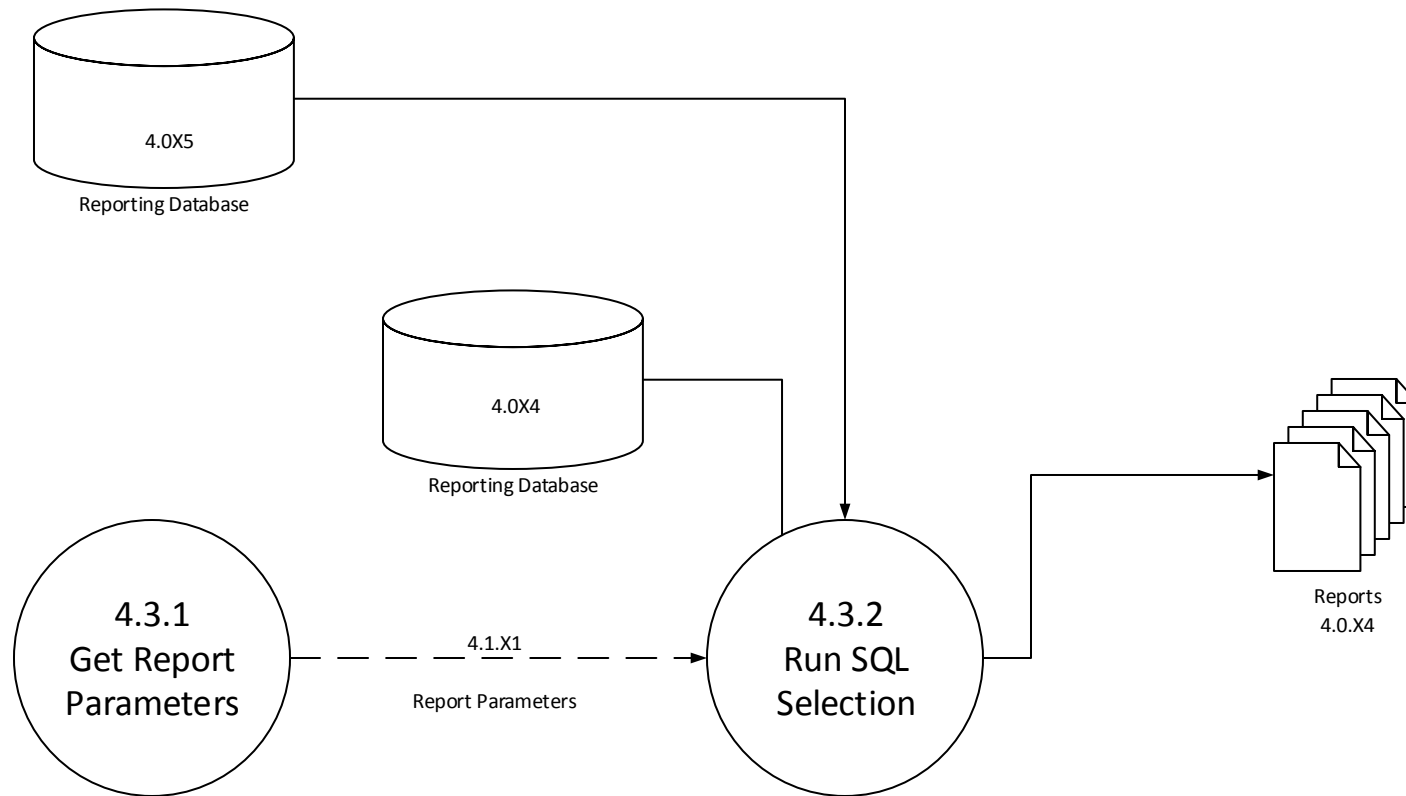

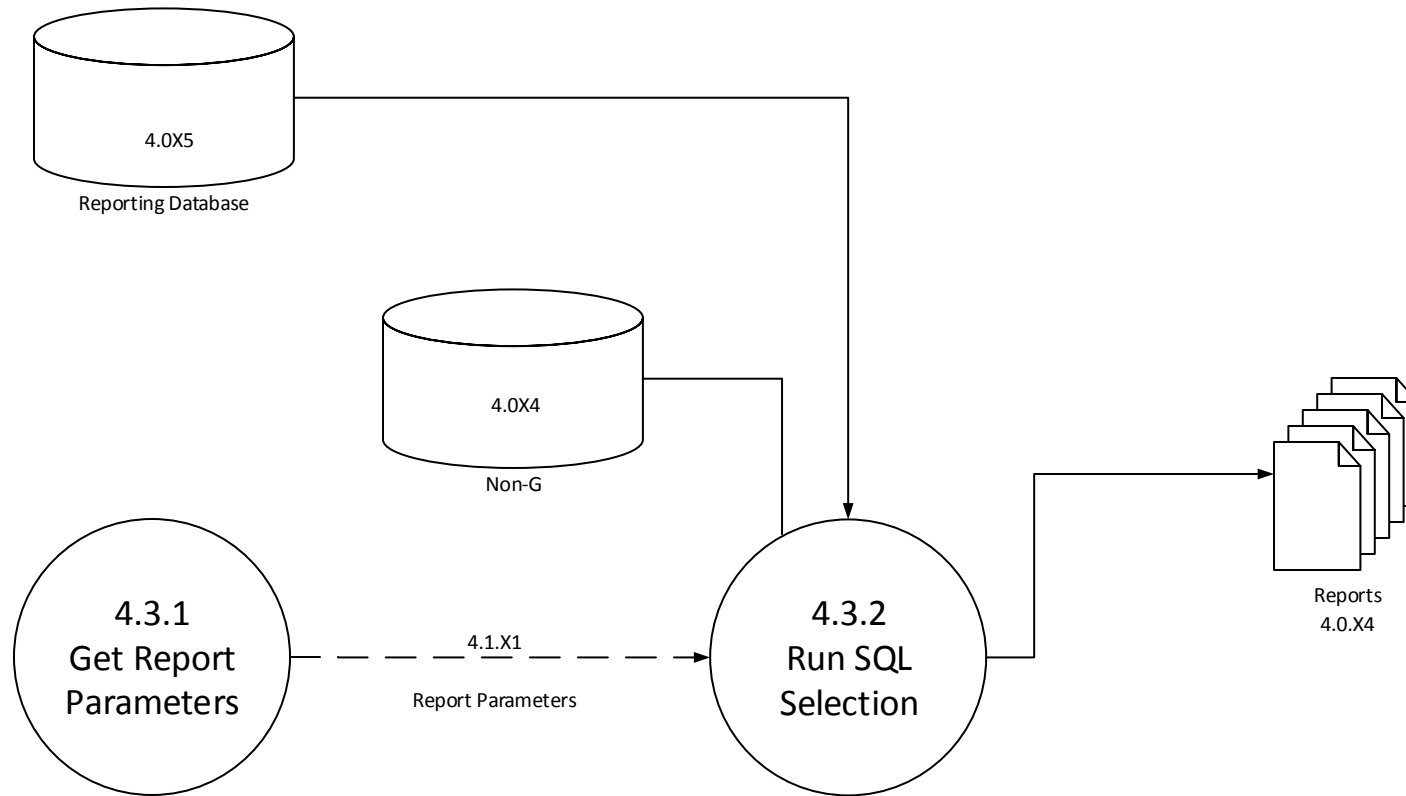

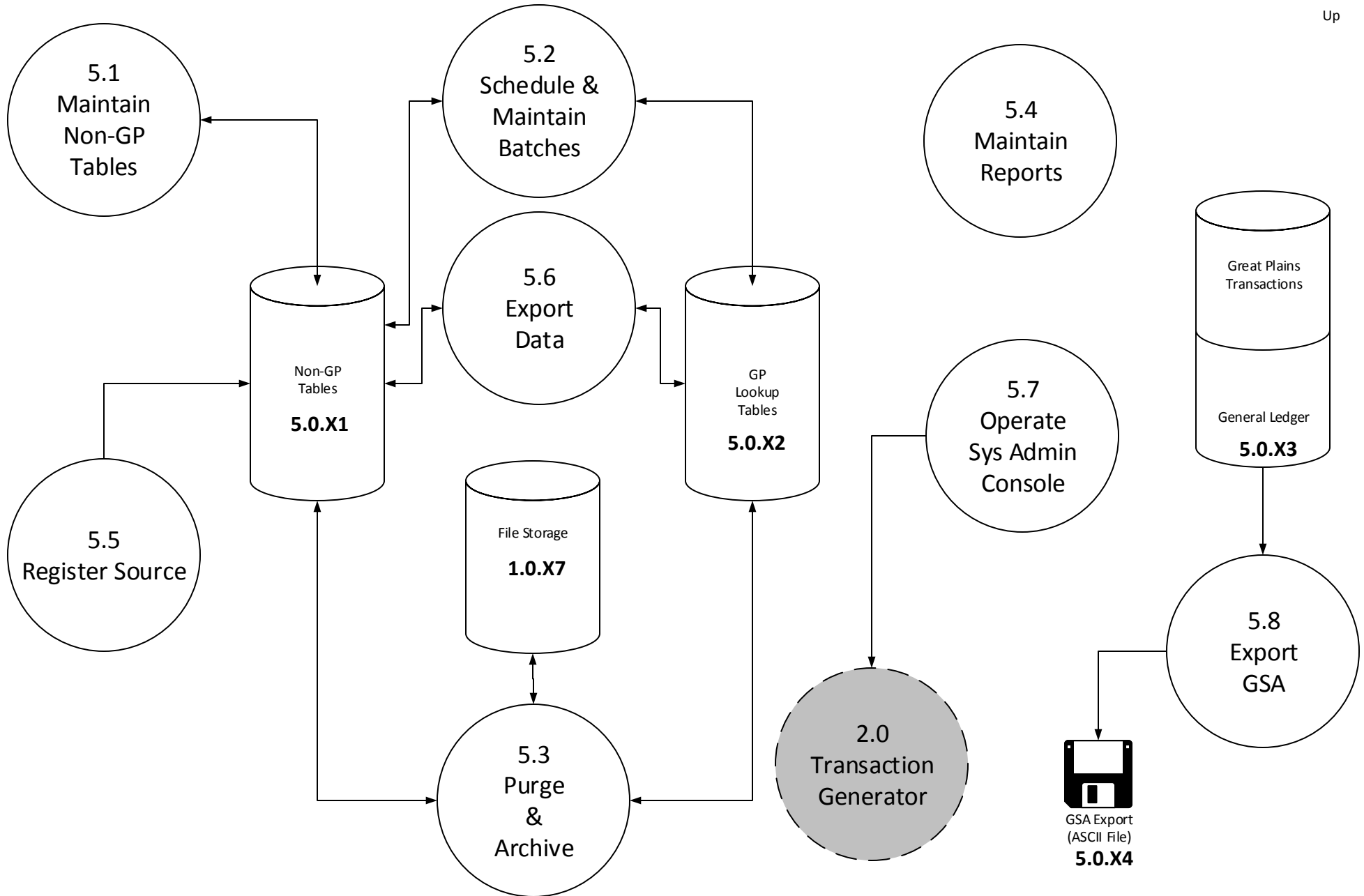



Up

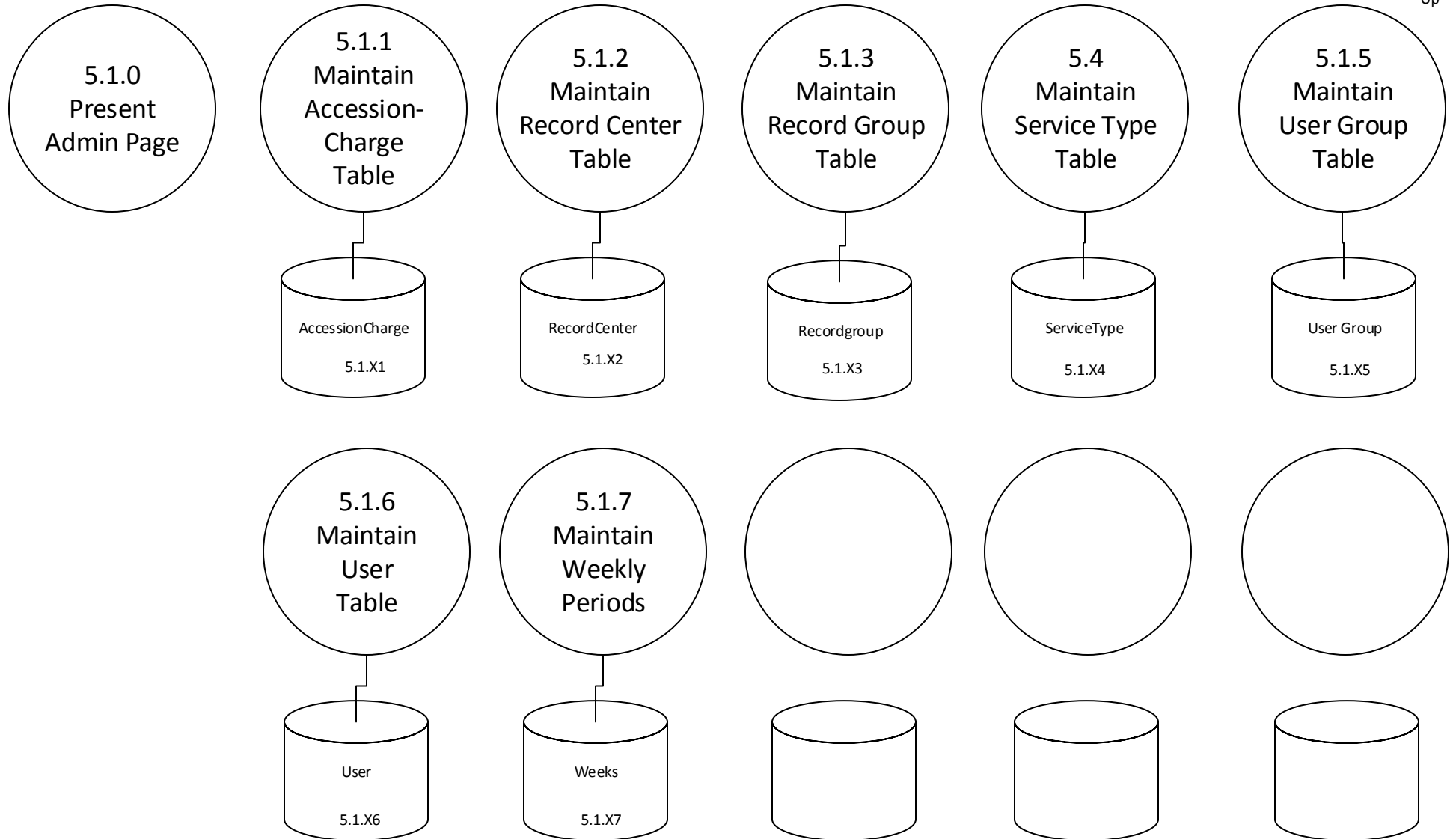

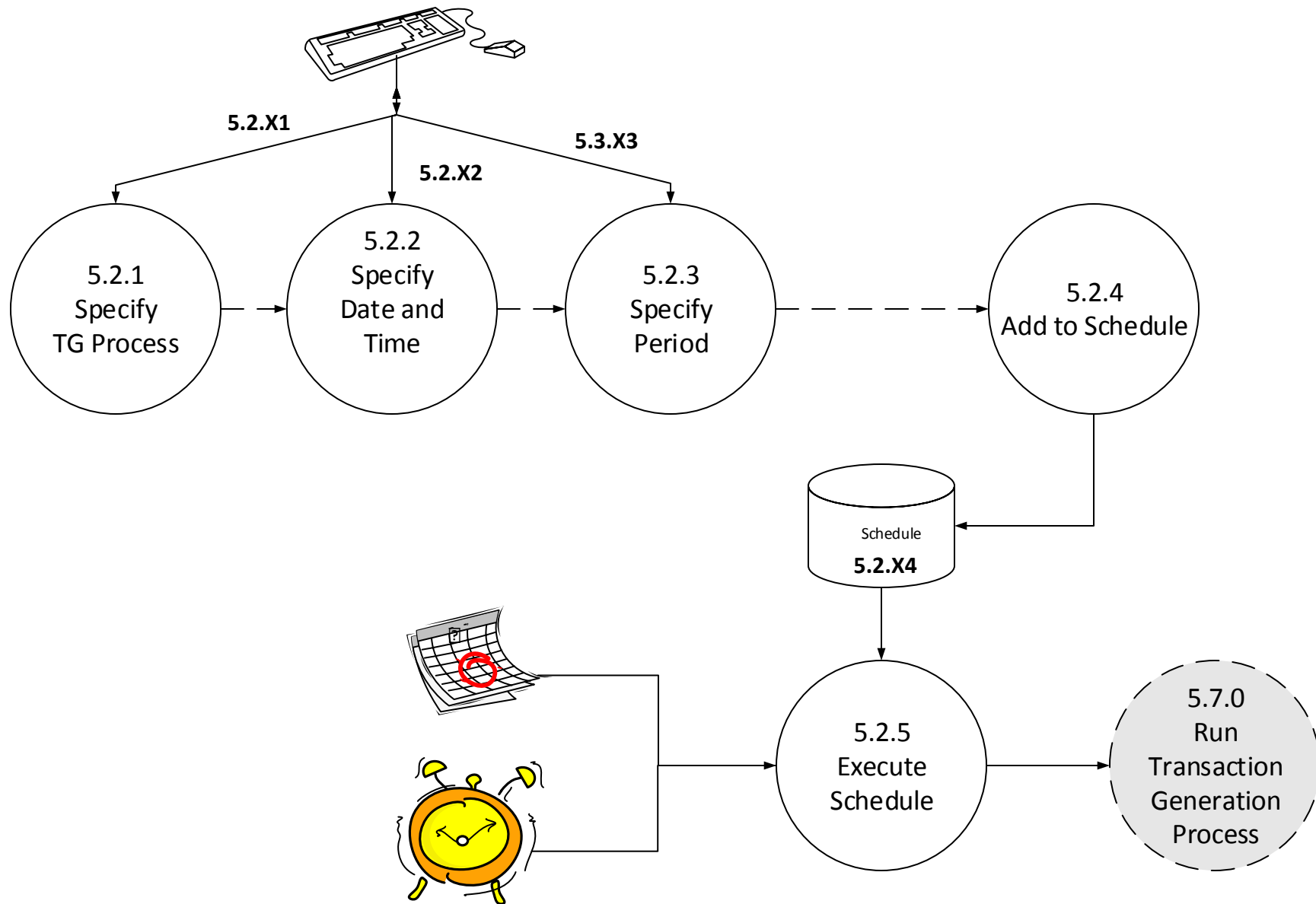

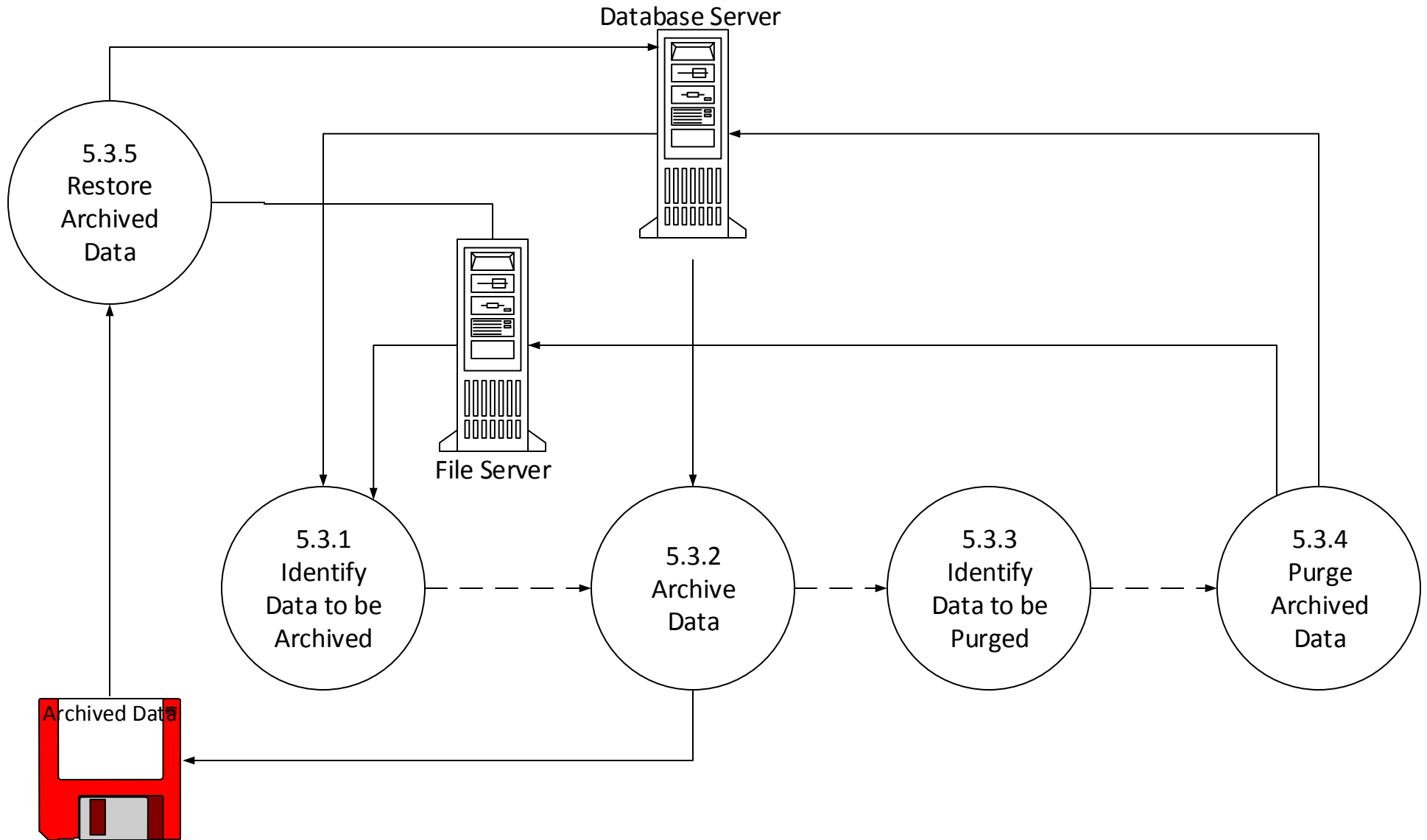

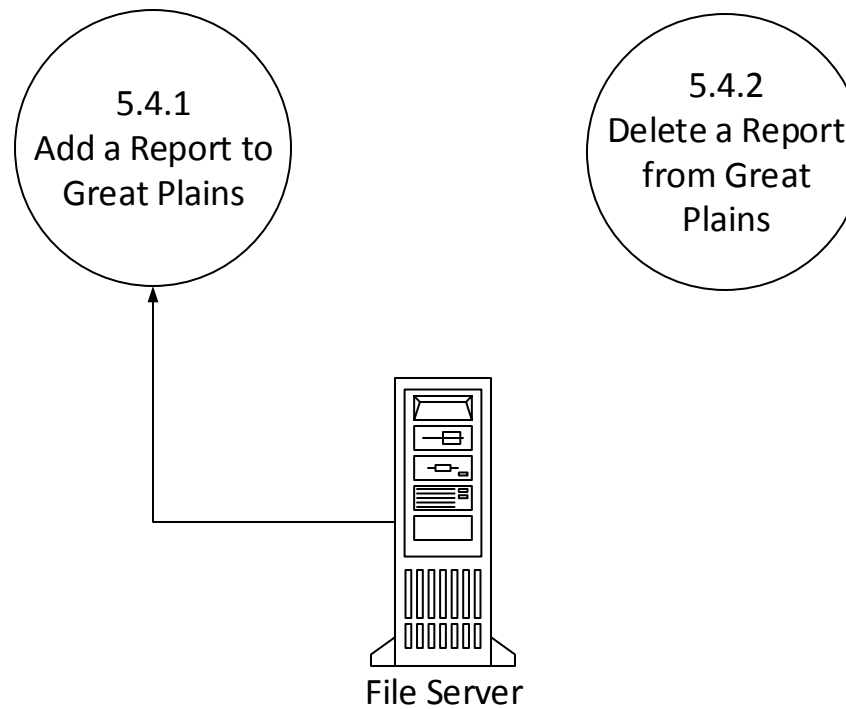

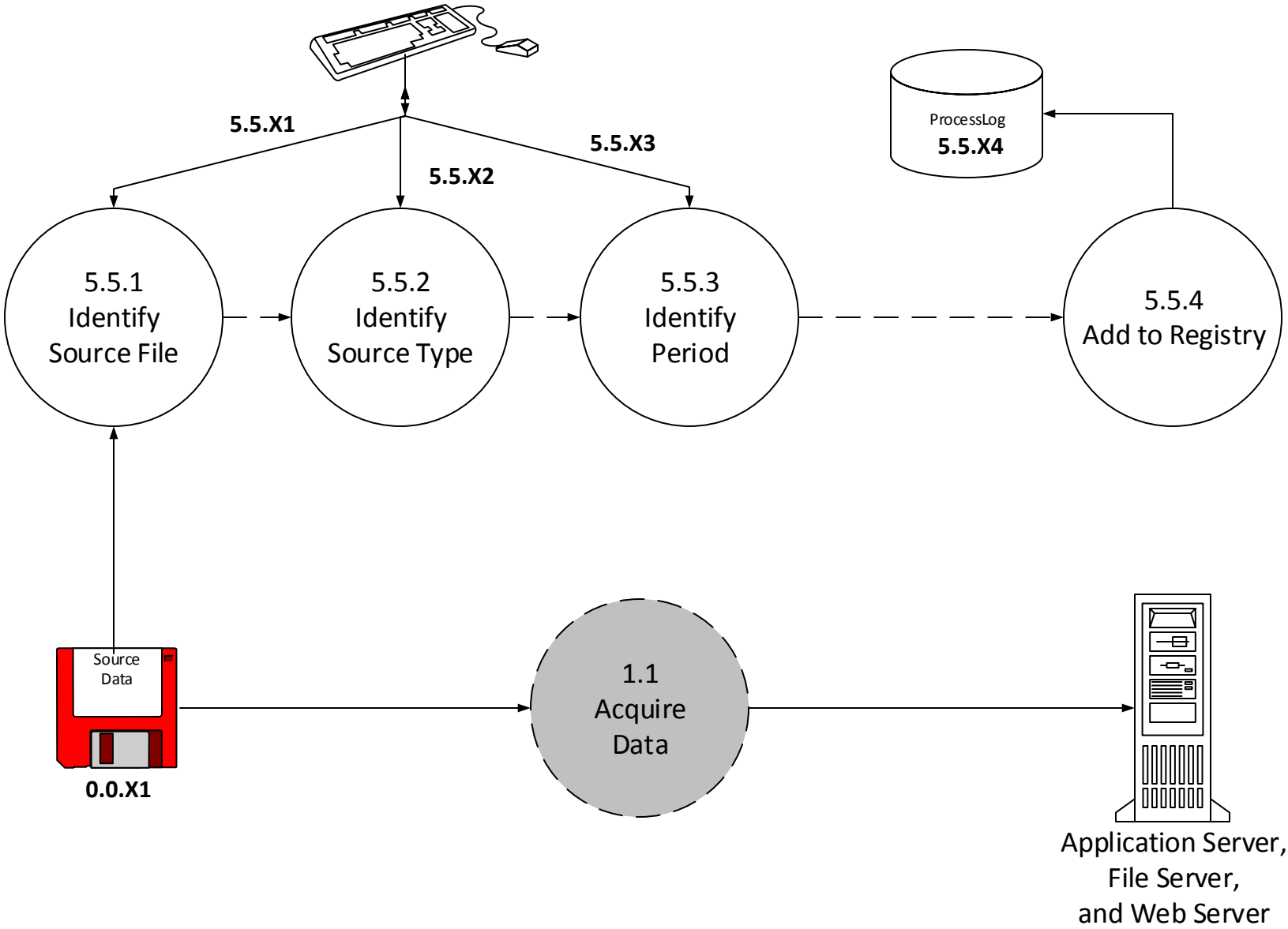



Up

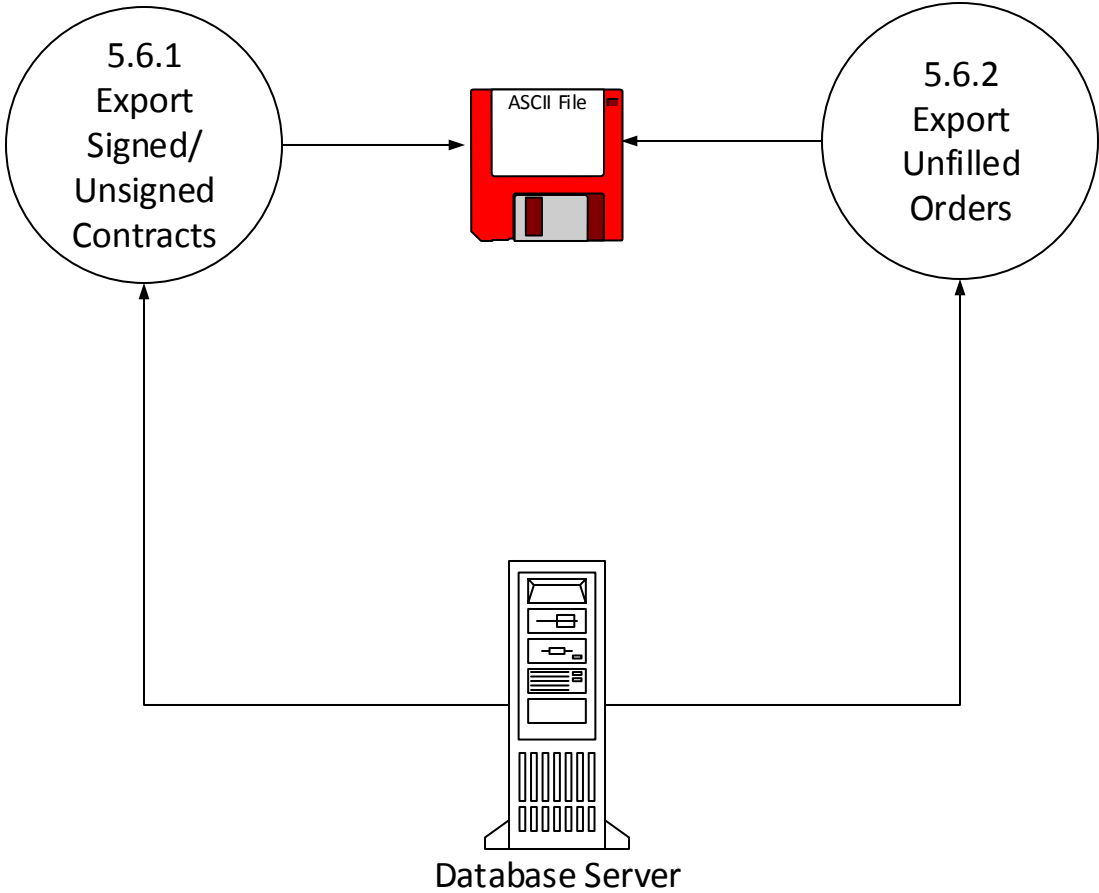

5.7 Operate Sys Admin Console

v4.3

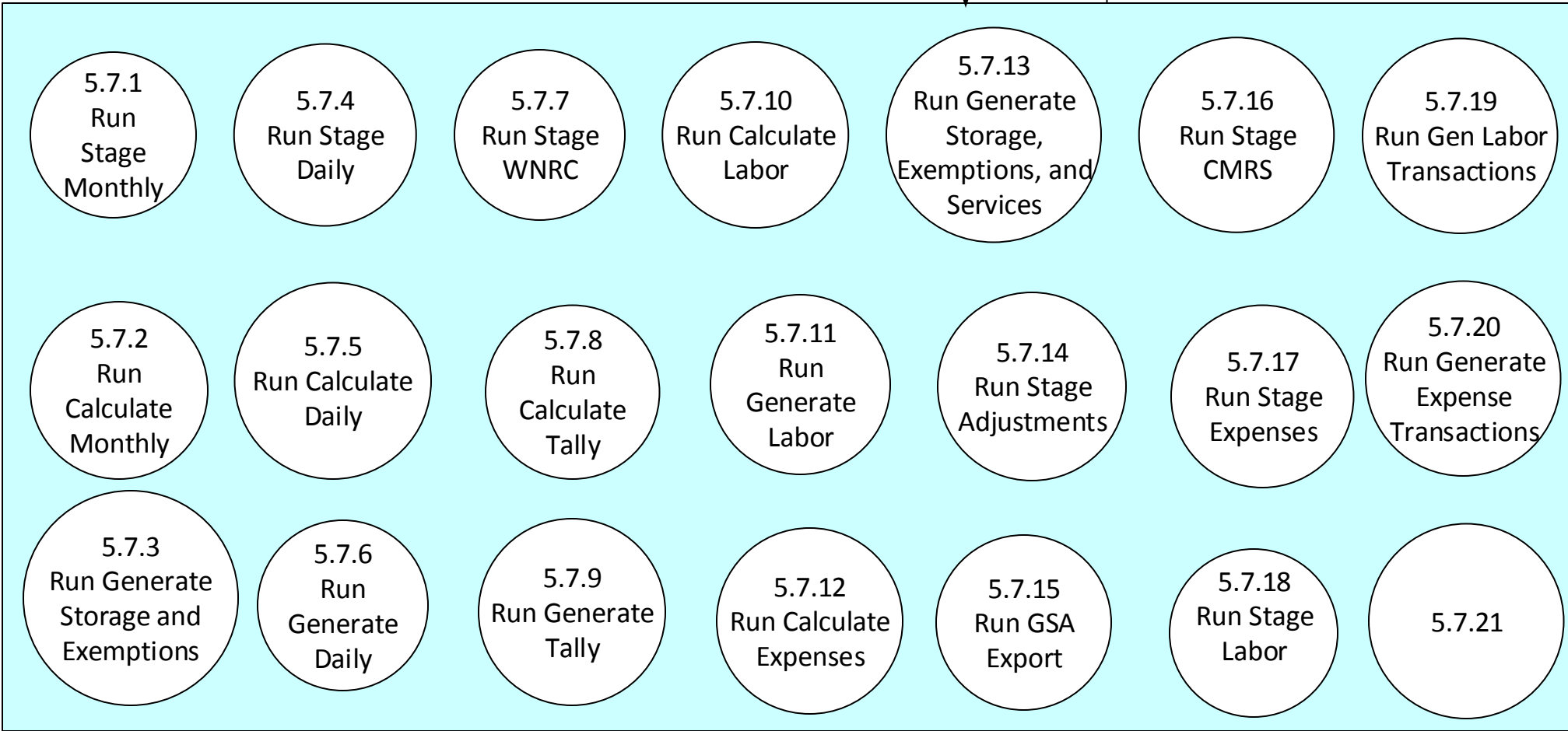
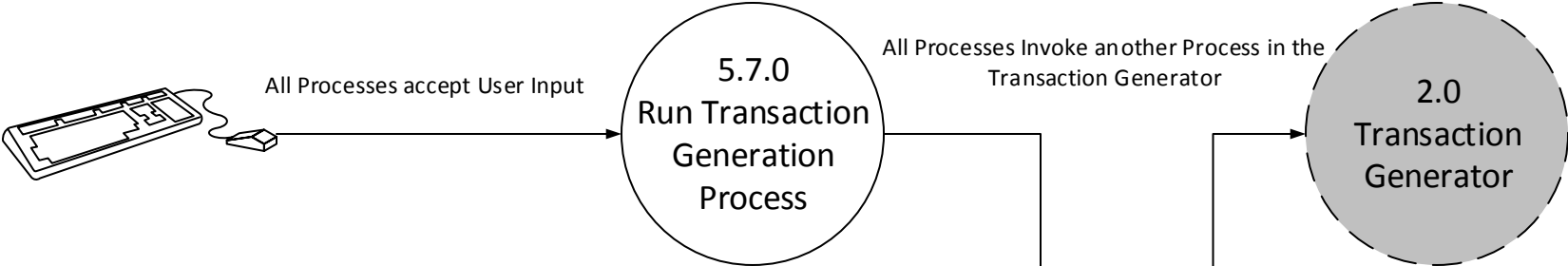

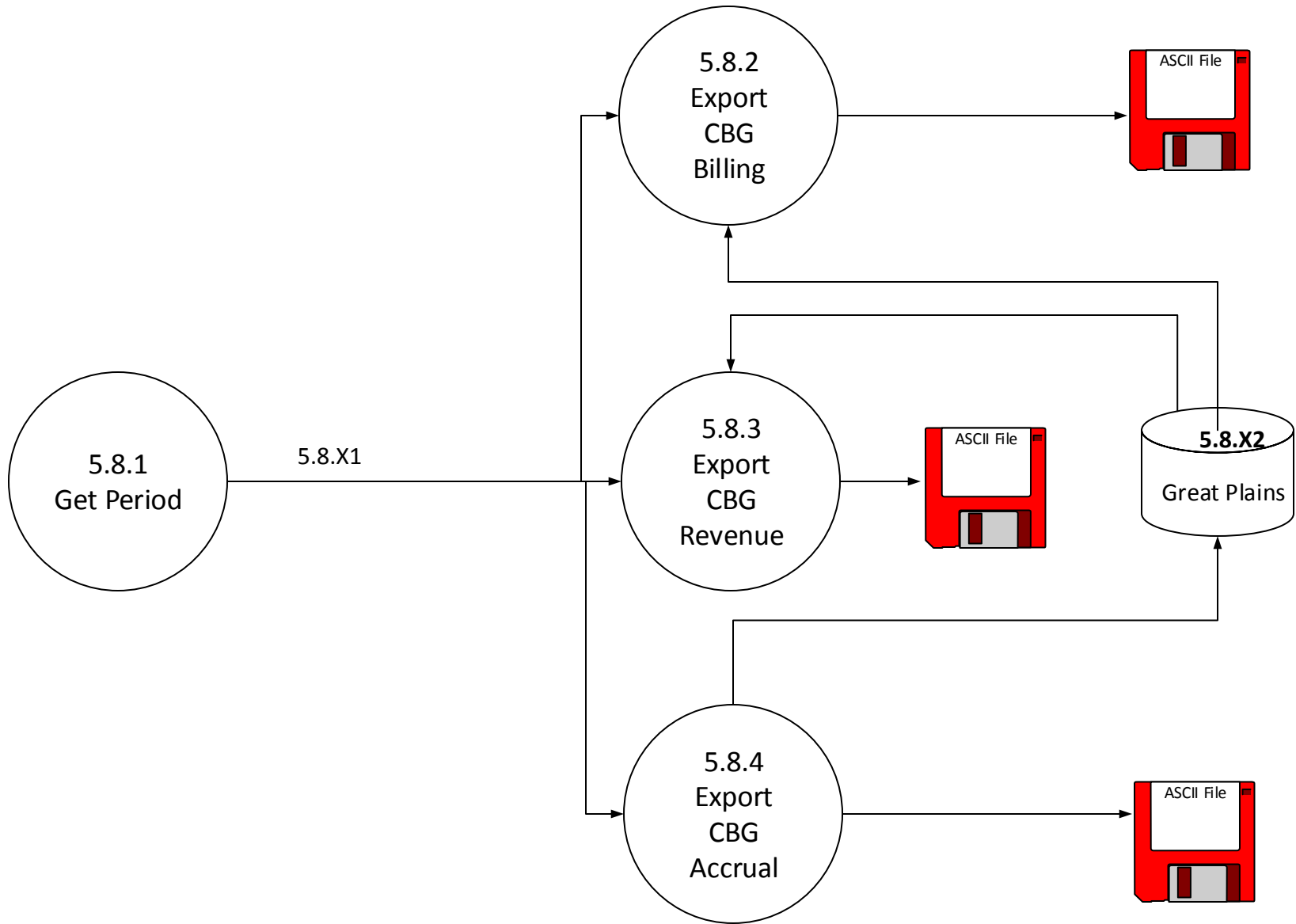

5.9 Year End Rollover

v4.3

