

CONFIDENTIAL

7 April 1995

MEMORANDUM FOR: J. Barry Harrelson @ DA

FROM:

IMS/ESG/HCS

SUBJECT:

Response to ARRB Questions / Requests

REFERENCE:

Memo dtd 6 March 1995 to Ellie Neiman re ARRB Initial Review of Oswald 201 File

1. In response to ARRB the DO has the following answers and /or comments to the specific questions raised by Mr. Gunn during his review of the OSWALD 201 file.

a. **RYBAT**- The sensitivity indicator RYBAT is used on correspondence whenever, in the judgment of the originator and releasing officer, the correspondence concerns sensitive operational or administrative matters. When used RYBAT will appear on the slug line along with other pertinent action indicators or cryptonyms to ensure the protection of sensitive text information.

b. **CI/SIG** - the "I" in SIG stands for " investigations " and appears in the Birch O'Neal testimony and also in CSI No. 70-1 dtd 2 March 1955 [a copy attached herewith] ; this particular document was released in full in Reel 48 folder 18 of the JFK microfilm holdings.

c. **VR** - Indicates that a " vital records " copy of the cable message was provided to the cable secretariat archives for its use in the necessary microfilming of the message at a later date - this automatic dissemination to VR ensures a good microfilm image copy for records storage.

d. **D-200-5-41** - The "D" indicates a processing code used by the records analyst to place a cross referenced copy of the same document into a particular file other than the main file . The file number 200-5-41 is the official GPFLOOR file -all documents originally assigned to this file have been reclassified to other subject files . The GPFLOOR file was closed out with the last document filed dated 26 August 1968 [see JFK Reel 48 folder 29 for a listing of documents processed from this file].

e. **SLUG LINE** - The crypts released elsewhere in the text of a message are always protected in the slug line along with other indicators as a method to preclude reconstitution of DO files; for the release of the crypts in the slug line could build sufficient information to reconstruct sensitive operational information the DO is trying to protect.

f. **DO/WH Organizational Chart** - [see attached CSI No 70-1 dtd 27 May 1955 and updates written in from cable chrono information]- the second attachment dtd 5 July 1978 authored by the CIA History Staff answers the original request for this information.

g. **HRG Review Guidelines** - On 15 March the DO provided HRG with a green

CONFIDENTIAL

CONFIDENTIAL

highlighted copy of the guidelines indicating any information which it considers sensitive and for review only by Mr. Gunn while at HRG [per discussion with Barry this is not a sanitized version of the guidelines].

CC:

CONFIDENTIAL

~~CONFIDENTIAL~~~~SECRET ATTACHMENT~~~~INTERNAL USE ONLY~~

7 April 1995

RESPONSE TO ARRB QUESTIONS

[03]

CIA SPECIAL COLLECTIONS
RELEASE AS SANITIZED
2000

In response to ARRB the DO has the following answers and /or comments to the specific questions raised by Mr. Gunn during his review of the OSWALD 201 file.

- a. RYBAT- The sensitivity indicator RYBAT is used on correspondence whenever, in the judgment of the originator and releasing officer, the correspondence concerns sensitive operational or administrative matters. When used RYBAT will appear on the slug line along with other pertinent action indicators or cryptonyms to ensure the protection of sensitive text information.
- b. CI/SIG - the "I" In SIG stands for " investigations " and appears in the Birch O'Neal testimony and also in CSI No. 70-1 dtd 2 March 1955 [a copy attached herewith] ; this particular document was released in full in Reel 48 folder 18 of the JFK microfilm holdings.
- c. VR - Indicates that a " vital records" copy of the cable message was provided to the cable secretariat archives for its use in the necessary microfilming of the message at a later date - this automatic dissemination to VR ensures a good microfilm image copy for records storage.
- d. D-200-5-41 - The "D" indicates a processing code used by the records analyst to place a cross referenced copy of the same document into a particular file other than the main file . The file number 200-5-41 is the official GPFLOOR file -all documents originally assigned to this file have been reclassified to other subject files . The GPFLOOR file was closed out with the last document filed dated 26 August 1968 [see JFK Reel 48 folder 29 for a listing of documents processed from this file].
- e. SLUG LINE - The crypts released elsewhere in the text of a message are always protected in the slug line along with other indicators as a method to preclude reconstitution of DO files; for the release of the crypts in the slug line could build sufficient information to reconstruct sensitive operational information the DO is trying to protect.
- f. DO/WH Organizational Chart - [see attached CSI No 70-1 dtd 27 May 1955 and updates written in from cable chrono information]- the second attachment dtd 5 July 1978 authored by the CIA History Staff answers the original request for this information.

~~INTERNAL USE ONLY~~~~CONFIDENTIAL~~

CONFIDENTIAL AND PROPRIETARY
OR RESTRICTED RIGHTS PROGRAM

SECRET

TENTATIVE
CSI NO. 70-1
CHAPTER V

**CLANDESTINE SERVICES
INSTRUCTION NO. 70-1**

2 March 1955

- (9) Recommends policy for Clandestine Services activities relating to the internal security of the United States and provides staff supervision over the collection and provision of information appropriate to United States internal security agencies.

2. SPECIAL INVESTIGATION UNIT

a. Major Functions

Performs the CI investigation and analysis of any known or potential security leak in the Clandestine Services organization, whether in headquarters or in the field, from the standpoint of its effect on (1) existing operations, and (2) the cover of personnel. In performing this function, maintains close working relations with the Security Office, the latter being primarily concerned in such cases from Agency security rather than an operational security standpoint.

3. ADMINISTRATION STAFF

a. Major Functions

- (1) Guides and supports CI elements in the field of organization, personnel, specialized procurement and supply, finance, budget, travel, publications, and general administrative facilities.

Note: Since CI personnel have the FI career designation, Career Management functions are largely performed by FI Staff.

- (2) Performs counterpart functions within the CI Staff on behalf of those Agency support units responsible for procedures relating to personal safety, physical security, and miscellaneous administrative controls.
- (3) Coordinates with the other components of CI Staff to insure correlation of their activities with the administrative capabilities of the Agency.

4. LIAISON STAFF

a. Major Functions

- (1) Provides staff supervision and guidance in matters relating to liaison with other United States Government agencies on matters pertaining to counterespionage and operationally related matters pertaining to internal security.
- (2) Provides guidance and suggestions, as requested and appropriate, to other components of CIA in matters pertaining to counterespionage and internal security involving liaison with other United States Government agencies.
- (3) Coordinates with the Security Office, or other components of CIA as appropriate, matters involving liaison with other United States Government agencies on questions which have counterespionage aspects and other aspects intermingled or not clearly delineated.

5. SPECIAL PROJECTS DIVISION

a. Major Functions

The Chief, Special Projects Division, is responsible for the handling of such special projects as are assigned to him by the Chief, CI, or directly by the Chief of Operations or the Deputy Director (Plans).

"RIF"
this document
* released previously
Reel 48, F# 14

SECRET

CLANDESTINE SERVICES
INSTRUCTION NO. 70-7 1-1

TENTATIVE
CSI NO. 70-7 1-1

ORGANIZATION
27 May 1955

*Recd. by
CSI 1-10, 7 Nov. 1970*

RELEASE

10 June 1955

Thom Kirk

ORGANIZATION AND FUNCTIONS OF THE
CLANDESTINE SERVICES

CHAPTER VII, PART A - AREA DIVISIONS

*Note:
Figures 1 thru 6 to this point
were recorded by
CS 75-99, 25 Nov 1960*

Copy No. 699

*207-298-55 } 6cc (+overjetz)
5/27/55*

SECRET

*207-13-56 } 150
22 Dec 55 } reprints*

SECRET

CLANDESTINE SERVICES
INSTRUCTION NO. 70-1TENTATIVE
CSI NO. 70-1ORGANIZATION
27 May 1955ORGANIZATION AND FUNCTIONS OF THE
CLANDESTINE SERVICES

CHAPTER VII, PART A - AREA DIVISIONS •

1. MISSION

Under the direction of the Deputy Director (Plans) through the Chief of Operations, and under the staff and technical guidance of the Chiefs of the Senior Staffs, the Chief of an Area Division is responsible for planning, developing, and directing, and for providing necessary support for, all clandestine operations undertaken in his geographic area in the accomplishment of the DD/P mission, and for the coordination and support of DD/P clandestine operations mounted from his area.

2. ORGANIZATION

(see organization charts, Figures 1 - 6.)

3. MAJOR FUNCTIONS

The Chief of an Area Division will:

- a. Plan, develop, direct, and support all Federal espionage operations and activities within his geographic area.
- b. Plan, develop, direct, and support all psychological and paramilitary operations and activities within his geographic area (except as qualified in paragraph c., below, for certain IO operations) to include propaganda programs, economic warfare, guerrilla warfare, sabotage, evasion and escape, PP stay behind and penetration operations, and air-maritime operations.
- c. In collaboration with the IO Division, coordinate and direct the utilization, within his geographic area, of international organizations including labor operations, and provide necessary support for any IO operations based in his area.
- d. Provide necessary support, in collaboration with the SR Division, for any SR operations or activities based in his geographic area.
- e. Plan, develop, direct, and support counterespionage and counterintelligence operations and activities within his geographic area.
- f. Develop and maintain CE information on foreign intelligence services and personalities of counterintelligence interest relating to his geographic area.

* NOTE: This standardized functional statement applies to the following six Area Divisions: SE, FE, NE, SE, WE, and WH. In view of the specialized nature of SR and IO activities, individual functional statements for these two Divisions are separately published as PART B and PART C, respectively, of Chapter VII.

SECRET

DEFENSIVE
 CSI NO. 70-1
 CHAPTER VII - PART A

CLANDESTINE SERVICES
 INSTRUCTION NO. 70-1

27 May 1955

- g. Prepare intelligence and counterintelligence information reports pertaining to his geographic area for dissemination to appropriate Government agencies in accordance with established requirements.
- h. Prepare or ensure the preparation of operational plans, programs, and projects for the accomplishment of the mission assigned to his geographic area, including operational and support annexes and/or administrative plans, and effect necessary coordination of same with other Agency components.
- i. Assist in the development of pertinent strategic cold war plans as required.
- j. Assist in the development of hot war plans pertaining to his geographic area and provide as directed for the allocation, transfer, or generation of assets to meet accepted hot war obligations.
- k. Administer all defector matters within his geographic area.
- l. Provide guidance and direction to the operational and administrative activities conducted by field stations in his geographic area, to include the development and, after approval, transmission of letters of instruction and related mission directives as appropriate and required.
- m. Assure that appropriate cover is provided for all clandestine activities within his geographic area.
- n. Coordinate and supervise the establishment and activation, and direct the operation, of field stations and facilities necessary to accomplish in his geographic area the mission assigned to his division.
- o. Ensure that adequate operational, personnel, materiel, and physical security is maintained within his headquarters and overseas areas of responsibility.
- p. Implement personnel, training, and rotation programs in accordance with Agency regulations.
- q. Ensure that headquarters and field elements of his division comply with all operational and administrative policies, procedures and instructions of the Agency.
- r. Regulate and monitor all travel to and within his geographic area.
- s. As the established channel between headquarters and the field installations in his geographic area, monitor all communications to and from such field installations, and be responsible for either release of, or coordination on, all Clandestine Services communications, as well as those originated by non-DD/P components, which affect activities in his geographic area.
- t. Provide for continuous review, analysis, and evaluation of operations conducted within his geographic area.
- u. Conduct operational liaison with all components of the Agency, other Government agencies, and foreign governments as directed in the execution of the above mission and functions.
- v. Perform such other functions as directed by the DD/P.

FRANK G. WISNER
 Deputy Director (Plans)

Released by:
 Richard Belms
 Chief of Operations

4

SECRET

EE DIVISION

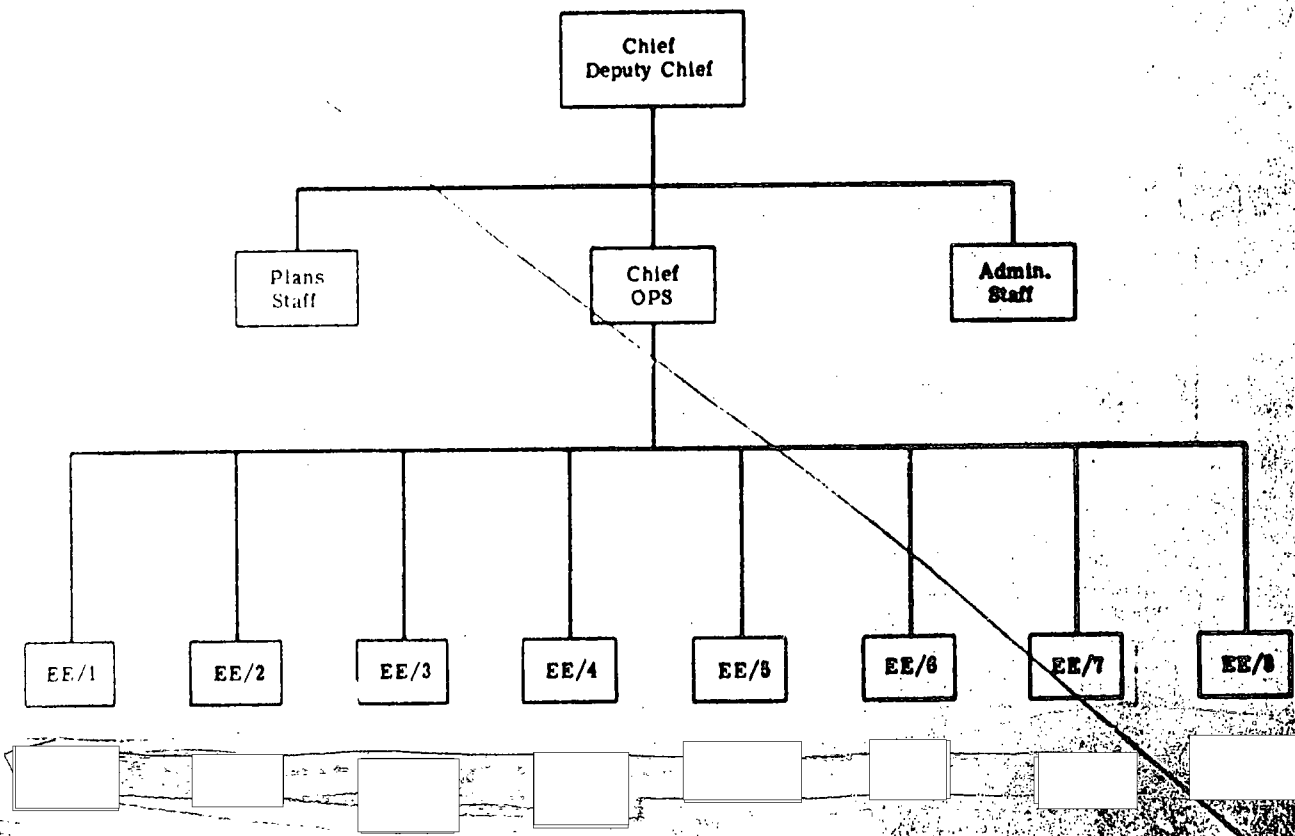

CLAUDESTEINE SERVICES
INSTRUCTION NO. 70-1

~~SECRET~~

REPLACEMENT
CHAPTER VII - PART 1
AT 14-00000

Figure 1

~~SECRET~~

Handwritten notes:
1977/11/17
1977/11/17

FE DIVISION

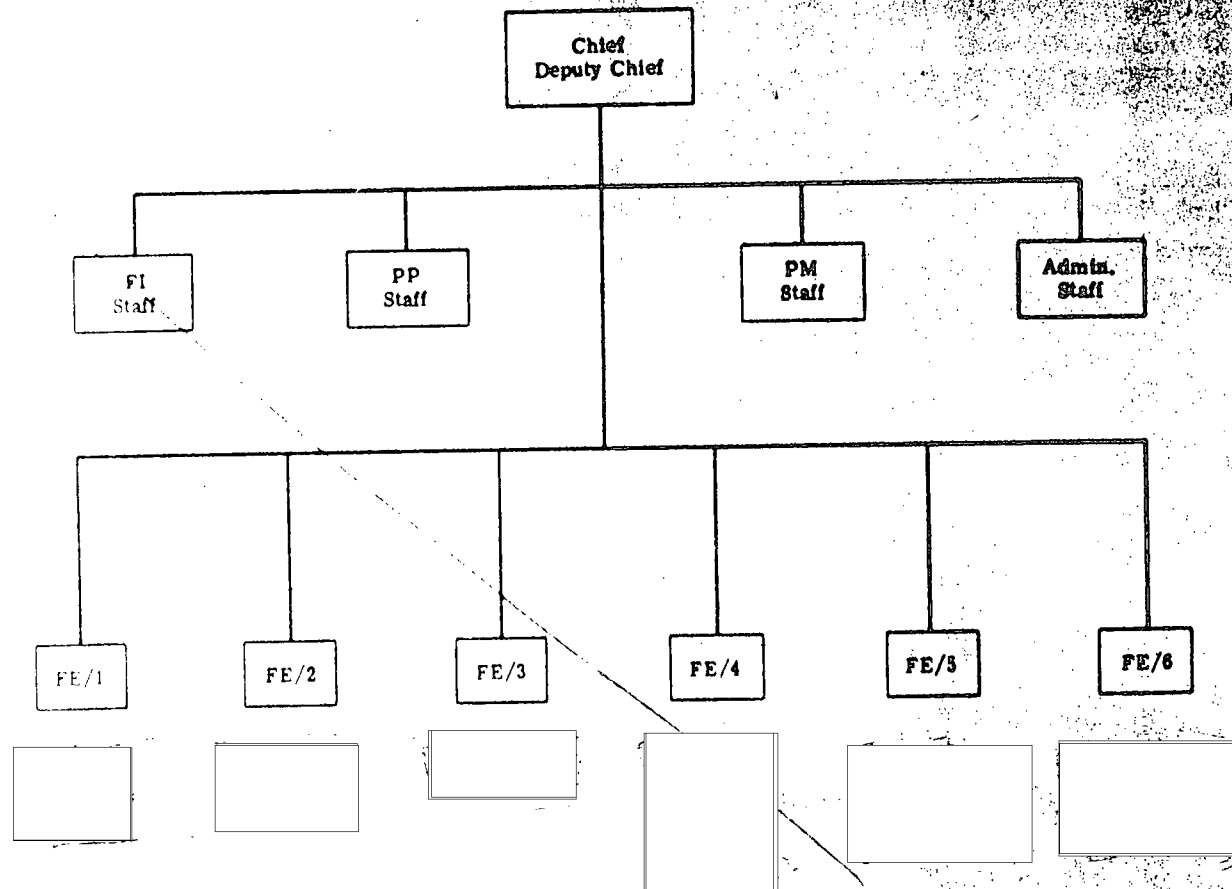

Figure 2

CLASSIFICATION SERVICES
INSTRUCTION NO. 70-1

~~SECRET~~

TENTATIVE
CSIR NO. 70-1
CHAPTER VII - PART A
27 MAY 1955

~~SECRET~~

NEA DIVISION

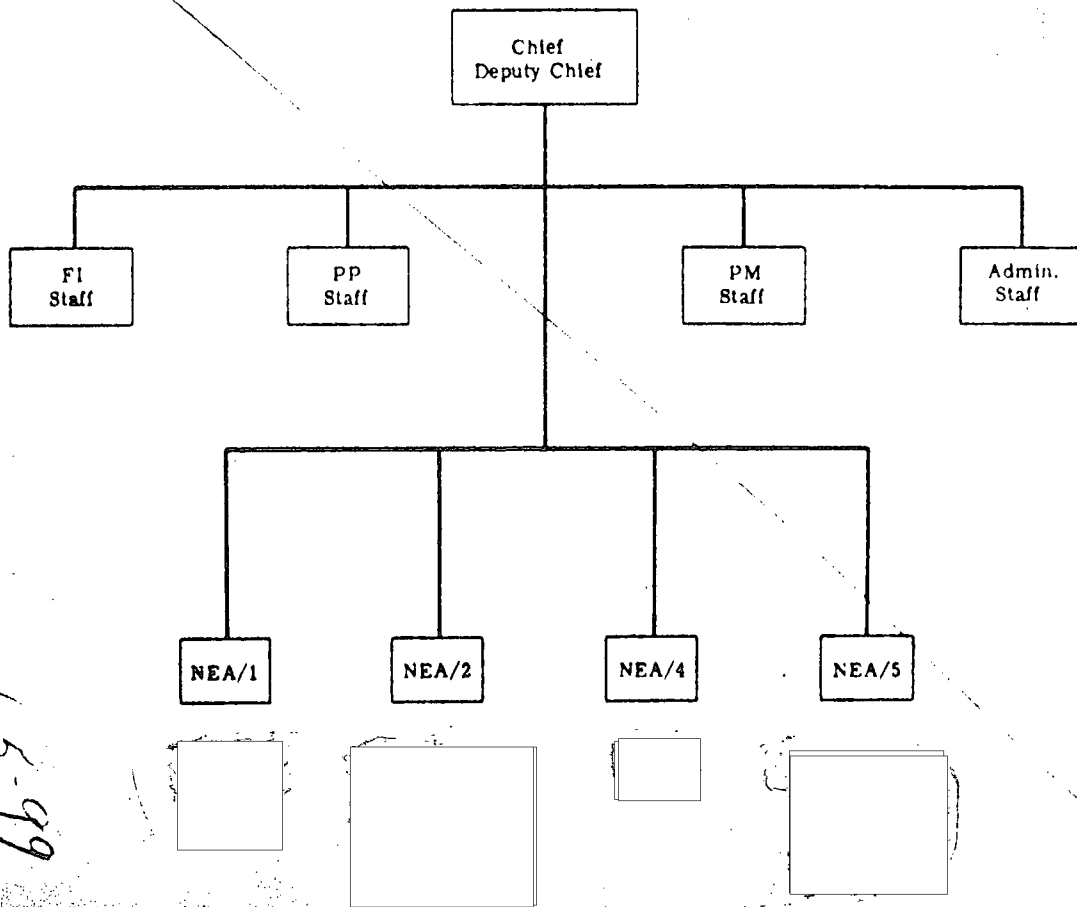

Figure 3

CLANDESTINE SERVICES
INSTRUCTION NO. 70-1

TENTATIVE
CSI NO. 70-1
CHAPTER VII - PART A
27 May 1955

~~SECRET~~

7

OSN 5-99

~~SECRET~~

~~SECRET~~

CLANDESTINE SERVICES
INSTRUCTION NO. 70-1

TENTATIVE
C/SI NO. 70-1
CHAPTER VII - PART A
27 May 1953

SE DIVISION

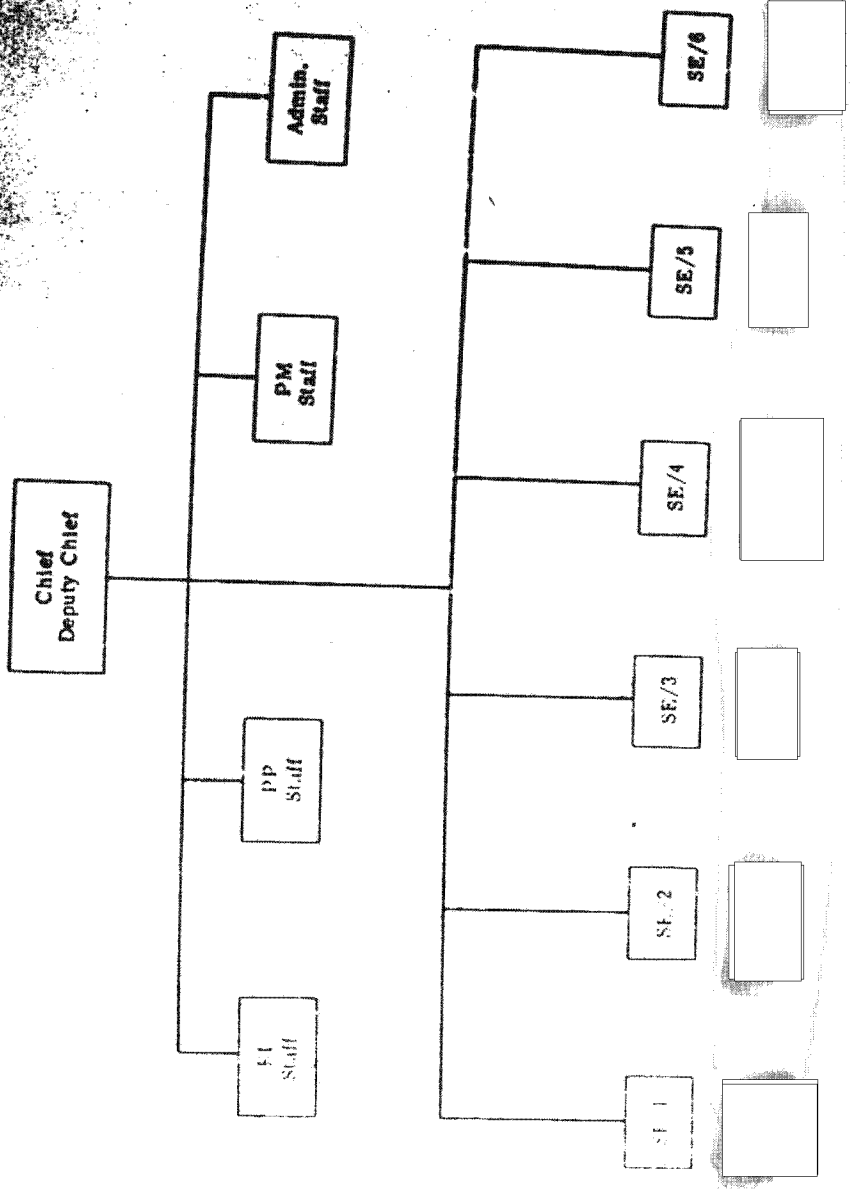

Figure 4

CLANDESTINE SERVICES
INSTRUCTION NO. 70-1

~~SECRET~~

TENTATIVE
CSI NO. 70-1
CHAPTER VII - PART A
17 May 1955

WE DIVISION

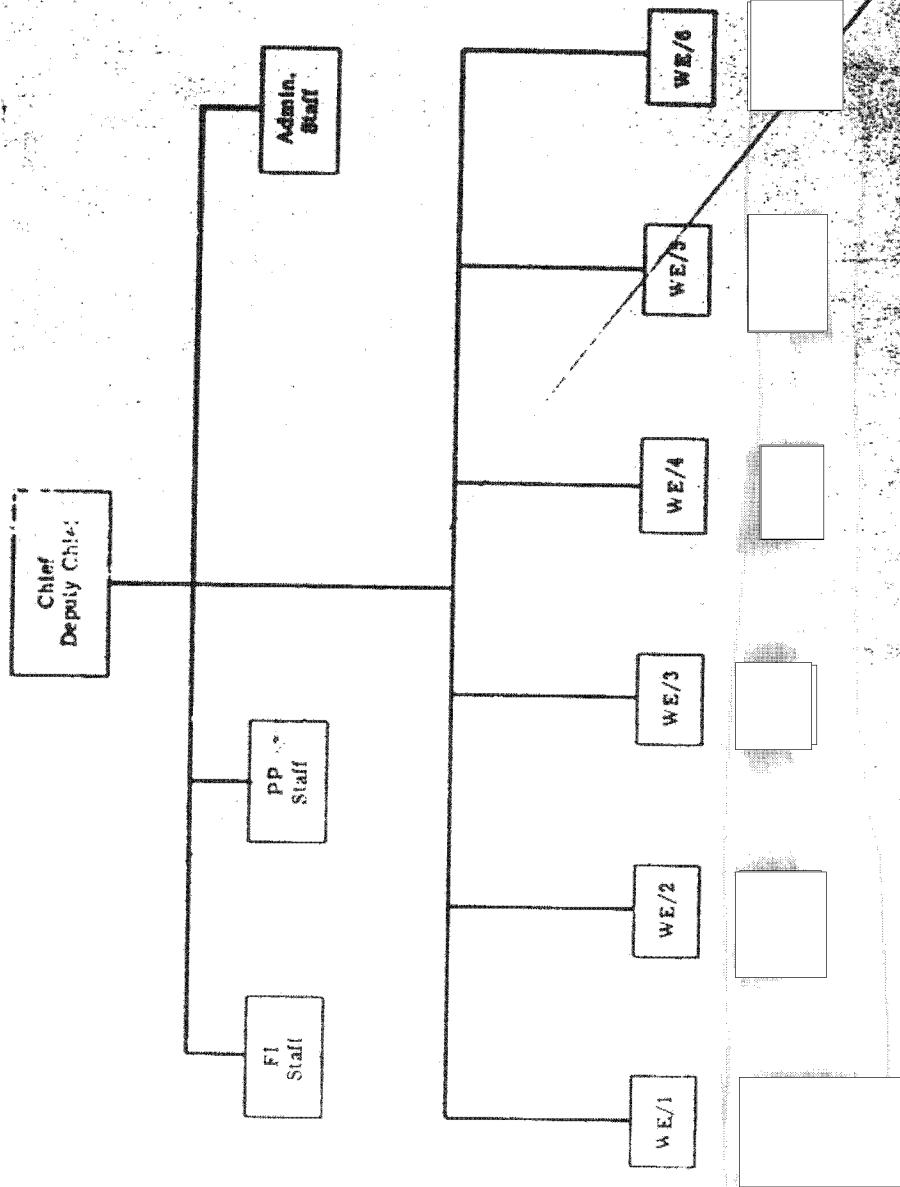

Figure 3

~~SECRET~~

~~SECRET~~

TENTATIVE
CSI NO. 70-1
CHAPTER VII - PART A

CLANDESTINE SERVICES
INSTRUCTION NO. 70-1

27 May 1955

WH DIVISION

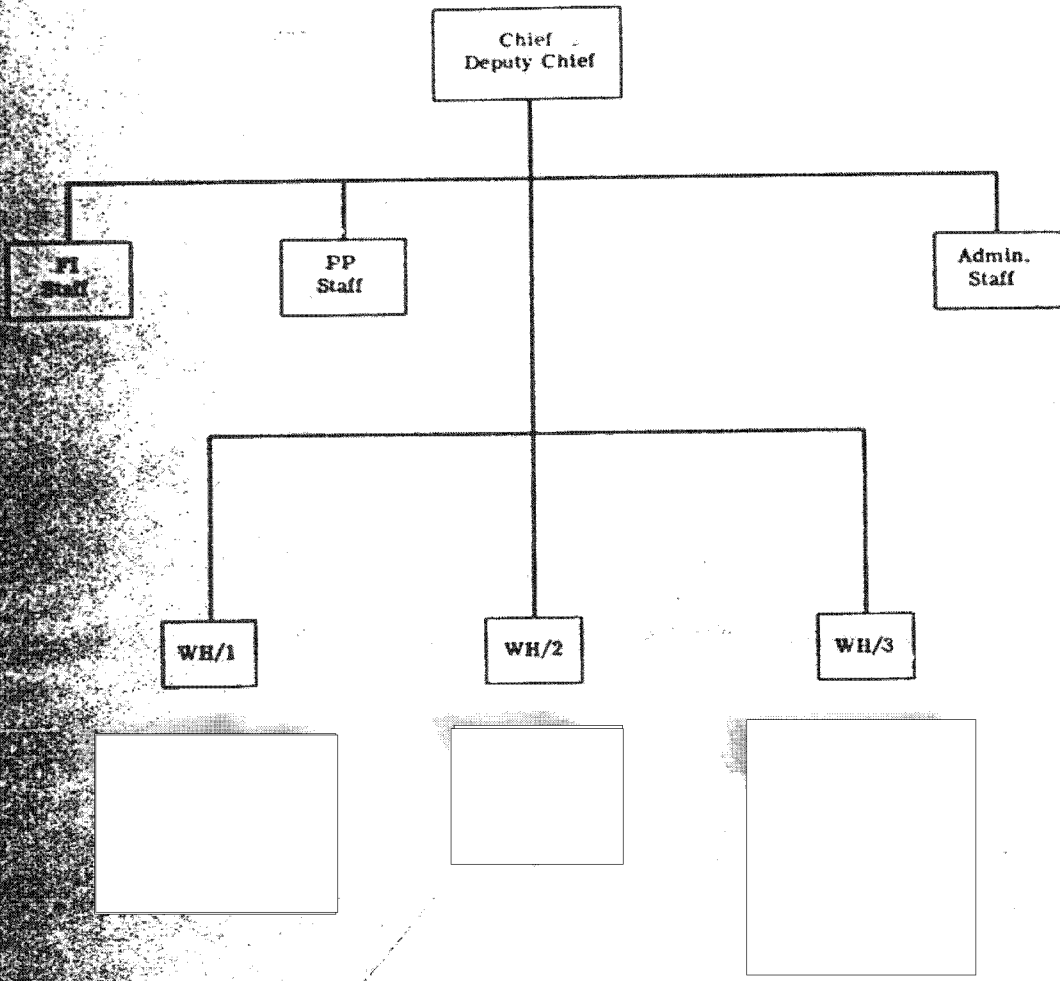

Figure 6

~~SECRET~~

bb-ENSD

** from changes (DIR) 1943*

WH/CA

WH 5,

WH 6

WH 7

WH / Support

WH / Ops

C-O-N-F-I-D-E-N-T-I-A-L

This Notice Expires 28 December 1960

CSN NO. 5-99

CLANDESTINE SERVICES
NOTICE NO. 5-99GENERAL
28 November 1960

Released: 30 Nov. 1960

RESCISSION NOTICE

The following publications are hereby rescinded:

Tentative CSI No. 1-1 (formerly CSI No. 70-1), Chapter II, Part A, ORGANIZATION AND FUNCTIONS, OFFICE OF THE DEPUTY DIRECTOR (PLANS), dated 11 March 1955.

Tentative CSI No. 1-1, Chapter II, Part B, ORGANIZATION AND FUNCTIONS, PLANNING AND PROGRAM COORDINATION STAFF, dated 22 July 1957.

Figures 1 through 6 of Tentative CSI No. 1-1 (formerly CSI No. 70-1), Chapter VII, Part A, ORGANIZATION AND FUNCTIONS, AREA DIVISIONS, dated 27 May 1955.

CSI 25-1, TRAINING OF CLANDESTINE SERVICES PERSONNEL., dated 21 January 1953.

CSI No. 70-3, AREA DIVISION TSS LIAISON OFFICERS, dated 24 February 1955.

RICHARD M. BISSELL, JR.
Deputy Director
(Plans)

C-O-N-F-I-D-E-N-T-I-A-L

~~SECRET~~

APPROVED FOR RELEASE 1993
CIA HISTORICAL REVIEW PROGRAM

5 4 48 PM '78
5 July 1978

MEMORANDUM FOR: Mr. Norbert Shephanek, PCS / LOC

FROM : Chief, CIA History Staff

SUBJECT : Organization Chart for the Deputy Directorate
for Plans (DDP), 1963

REFERENCE : Telecon from N. Shephanek to J. Pfeiffer,
30 June 1978, same subject.

1. In response to your telephone call of 30 June 1978, History Staff was unable to locate any single chart which showed the organization of the Deputy Directorate for Plans as of 1963. We did find a complete set of charts for the individual Staff Elements, the Functional Divisions, and the Geographic Area Divisions of the DDP as of 25 February 1963.

2. Based on the organization charts for these individual components (including the Office of the DDP), History Staff has prepared a chart which is believed to be an accurate reflection of the DDP organization as of 25 February 1963.

3. If you require further details concerning the organization of the individual components as of the date noted above, please let me know.

Jack B. Pfeiffer

Dr. Jack B. Pfeiffer
Chief, CIA History Staff
203 Key Building, x2621

Attachment:
Organization chart

UNCLASSIFIED when removed
from SECRET attachment.

~~SECRET~~

6694

E 2 IMPDET CL BY 018645

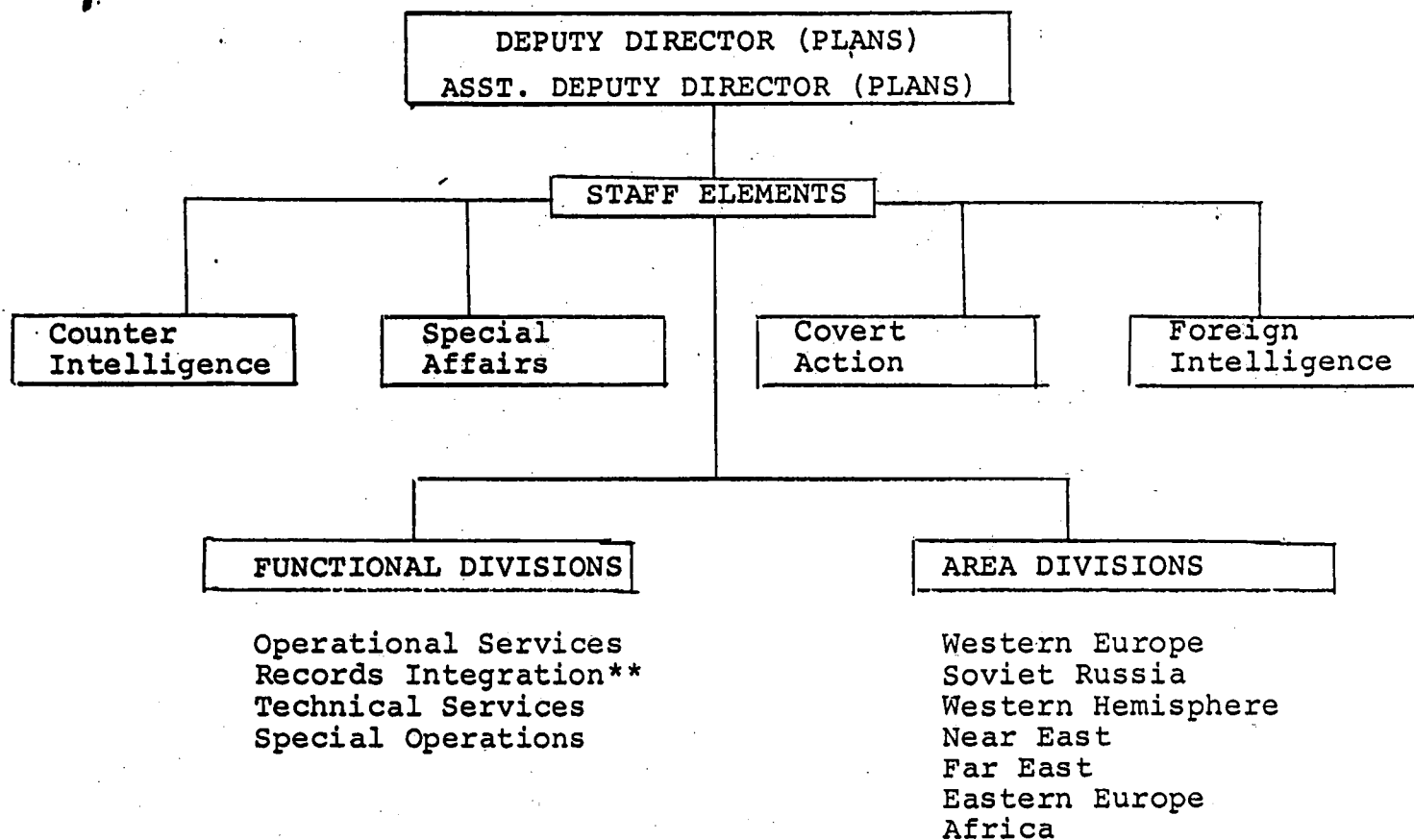
~~SECRET~~OFFICE OF THE DEPUTY DIRECTOR FOR PLANS*

* As of 25 Feb 1963

** As of 28 Dec 1963

~~SECRET~~